

tomorrow



EXPERIENCING TECHNOLOGY WITH SCHAEFFLER

Chip, Chip, Hooray!

How digitalization
enriches our lives

Data in transportation

Bits and bytes accelerate
mobility for tomorrow

Di|gi|ti|zat|ion - [dijīːtīːzā'shən]

is the representation of an object, image, sound, document or signal (usually an analog signal) by generating a series of numbers that describe a discrete set of its points or samples. The result is called digital representation, or more specifically, a digital image, for the object, and digital form, for the signal. In modern practice, the digitized data is in the form of binary numbers, which facilitate computer processing and other operations, but strictly speaking, digitizing simply means the conversion of analog source material into a numerical format; the decimal or any other number system can be used instead. Digitization is of crucial importance to data processing, storage and transmission, because it “allows information of all kinds in all formats to be carried with the same efficiency and also intermingled”. Unlike analog data, which typically suffers some loss of quality each time it is copied or transmitted, digital data can, in theory, be propagated indefinitely with absolutely no degradation. This is why it is a favored way of preserving information for many organizations around the world.

From: IGI Global

Di|gi|ta|li|zat|ion - [dijīːtlīːzā'shən]

is the integration of digital technologies into everyday life by the digitization of everything that can be digitized. The literal meaning of digitalization gives an apparent idea of a development and technology dependent world.

From: Wikipedia



DEAR READER,

To err is human. But that IBM CEO Thomas Watson of all people purportedly predicted that there was a world market for maybe five computers does make us chuckle a little bit today. However, Watson is said to have uttered this estimate as far back as in 1943, in the stone age of computers. It had only been two years earlier that the German civil engineer Konrad Zuse presented the Z3 as the first functional digital computer. How this invention and those that were subsequently based on it would revolutionize the world was indeed hard to foresee back then, even for the CEO of IBM.

PCs, the internet, e-mail and smartphones – to this day, like a huge wave, digitalization has been sweeping through all our lives bringing change at a pace we perceive to be rapidly increasing year after year. Telecommunications, technology, music, media, healthcare, commerce, banking and tourism – there is hardly a sector that has not been affected by digitalization and its offshoots. A term increasingly used in this context is disruption. The disruptive effect of digitalization is also a topic in the current issue of our technology magazine “tomorrow” to which I warmly welcome you.

A definition of disruption in the context of business offered by the Cambridge English Dictionary is “to change the traditional way that an industry operates, especially in a new and effective way.” And digitalization itself has in fact displaced a number of major companies from the marketplace such as U.S. photo giant Kodak and German mail order giant Quelle. On the other hand, new giants like Google and Amazon, to name but two, have emerged, plus of course, Apple with its iPad and iPhone products.

Digitalization plays an important part in Schaeffler’s corporate business strategy as well. We make use of our know-how to take digital technologies from the laboratory to the road – or into the factory hall. Today, Schaeffler even uses a supercomputer from IBM named Watson, after the company’s aforementioned CEO. More on this starting on page 62.

Watson is a cognitive system, a self-learning artificial intelligence. Google’s mastermind Raymond Kurzweil predicts that by 2029 computers might be smarter than humans. “tomorrow” addresses the impact this may have on society, beginning on page 100.

Schaeffler also taps into the potential of digitalization to advance its ideas for “mobility for tomorrow.” Electric drive systems are a keyword in this context. The article on page 54 reveals that they’re older than internal combustion engines. Would you have known? But in terms of its “mobility for tomorrow,” Schaeffler thinks in categories far below the level of the automobile as well. A case in point is an electric kickboard for the so-called “last mile,” in other words the distance between a commuter train station and work. Using an electric skateboard in Frankfurt, a colleague has tested how well this approach already works today.

Its enthusiasm for future technologies notwithstanding, Schaeffler does not neglect the further development of time-tested ones either. A good example of this is the torque converter which Schaeffler has made fit for use in hybrid powertrains that are becoming increasingly important around the world. This and many other exciting topics are covered on the following 118 pages. I wish you an enjoyable and informative read.

A handwritten signature in black ink that reads "Klaus Rosenfeld". The signature is fluid and cursive, written in a professional style.

Klaus Rosenfeld
Chief Executive Officer

global

A glimpse of the world

8

INNOVATIVE VIKINGS

Optimally networked, technophile, creative, bold – Scandinavia is a **citadel of digital progress**

14

GREAT OPPORTUNITY

Sounds funny, but is supported by arguments: threshold countries might be playing a **leading role in the field of automated driving**

18

MEGATREND URBANIZATION

London, Singapore and Toronto show how cities can achieve healthy growth

28

FIVE VISIONARIES

From Elon Musk to Sebastian Thrun – digital (**lateral**) thinkers whose ideas are advancing mobility for tomorrow

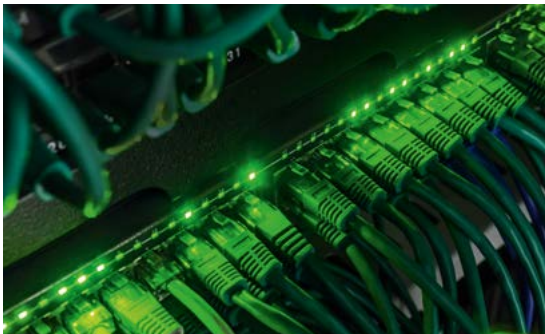

in motion

Innovations in the course of time

36

FROM STEERING WHEEL TO CONTROL CENTER

Race drivers used to look at two-spoke minimalism. Today, there's a lot that's reminiscent of a jet aircraft cockpit

42

GOOD TIMES, BAD TIMES?

Observations **from everyday life** show: while everything in the old days was more analog, it was seldom better

48

A PLETHORA OF CHANGE

The internet is used for booking trips, streaming music and hailing taxis by means of apps – digitalization has **rejiggered many business sectors**

54

A 100-YEAR DETOUR

Electric motors were the norm in the automobile's infancy. Then they disappeared – only to come back now charged with new energy

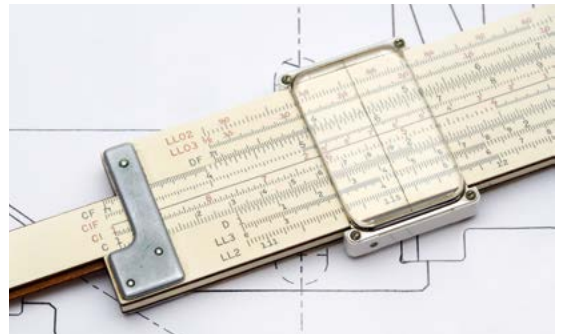

here and now

Living with progress

62 DIGITAL MEETS MECHANICAL

The industrial world is in a dramatic state of transformation. **Schaeffler shapes** it as a versatile development partner

72 “LAST MILE” TEST

How do I get to the bus stop and from the train station to my office at Schaeffler? Employee Michelle Biegel tried out an **e-skateboard**

78 GAME-CHANGING

The electronic connectivity and the hybridization of automobiles confront the **torque converter** with its most dramatic change ever

82 BEFORE IT'S TOO LATE

For a hundred years, Schaeffler has been developing **bearing solutions for trains**. The latest high-tech versions use sensors to report component wear

86 BIG BROTHER

Steering angle, brake pressure, speed – **race cars log data by the thousands on every meter**. Food for drivers, engineers and developers



outlook

Technology for tomorrow

94 MORE THAN MERE FANTASY

Many forms of travel known from **science fiction movies** have become reality – a cinematic time journey

100 WHO'S AFRAID OF ROBOT MAN?

Artificial intelligence is on the verge of surpassing human brain power. And then?!

104 THE AUTOMAKERS' LAB OF IDEAS

Silicon Valley is not only home to Apple and Google. BMW, Daimler, GM & company are visioning there as well

108 WHO DOES WHAT WITH WHOM AND WHY?

Shaping **mobility for tomorrow** is a complex task. Many players have to team up to master it

116 CHAPTER 4.0

After the steam engine, mass production and automation, the **fourth industrial revolution** is now being brought about by digitization

122 MASTHEAD



ONES AND ZEROS

— It may not weigh anything, but in the digital age it carries a lot of weight: data. And data will become even more important in the future. At an average annual growth rate of 22 percent, global data traffic will nearly triple in the next four years, according to a forecast by U.S. IT giant Cisco. The global internet community will be growing by more than a billion new users to 4.1 billion by 2020. The utilization of mobile end devices keeps increasing as well. Cisco predicts that in 2020 every human being on average will have access to 3.4 networked devices, in Western Europe even to 8.9. Videos are going to continue to account for the lion's share of total internet traffic – about 80 percent by 2020. According to this projection, some three trillion video minutes will be transmitted via the IP network around the globe per month. But it's not only humans that drive this development, as machine-to-machine communication in smart factories and the Industrial Internet of Things requires increasingly high broadband speeds. Another prediction of the study says that cloud-based data traffic is going to increase nearly fourfold. By 2020, 92 percent of the computing tasks will be handled in providers' clouds, according to Cisco. —

» **The Internet is the first thing that humanity has built that humanity doesn't understand, the largest experiment in anarchy that we have ever had** Eric Schmidt, CEO Google

global

A glimpse of the world

FORECAST OF MOBILE DATA VOLUME USE BY REGION

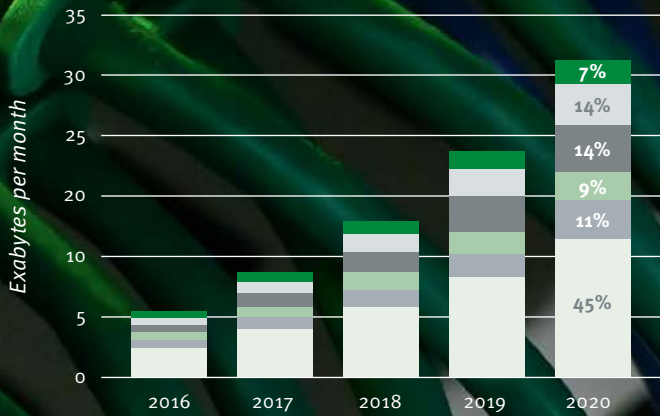

- Latin America
- Middle East and Africa
- Central and Eastern Europe
- Western Europe
- North America
- Asia/Pacific

Source: Cisco

Experts assume that by 2020, mobile end devices (smartphones and tablets) are going to transport 37 percent of the data volumes, and PCs only 33 percent.

THE DIGITAL IN THE NORTH

Europe's digital powerhouse is in the north. Denmark, Norway, Sweden and Finland are the global benchmarks in the field of information and communication technologies (ICT). The following report explains why this is the case and what it means.

— by Volker Paulun



HIGH

— Harald I, called Bluetooth, was a bully. He was king of Denmark and Norway in the 10th century and, like many of his Viking ancestors, enjoyed invading other countries, Normandy on particularly frequent occasions. But on the other hand, he also initiated the christianization of Scandinavia and united the northern countries that today are known as Denmark, Norway and Sweden. He overcame boundaries and established new connections – and that’s exactly why the inventors of Bluetooth technology named the globally used standard after the old king. His initials, H and B, in runic script, are perpetuated in the Bluetooth logo. Bluetooth was developed for the Swedish telecom giant Ericsson. Its Finnish neighbor and competitor contributed know-how as well. An ICT milestone made in Scandinavia – just one of many.

Denmark, Norway, Sweden and Finland are digital hotspots not only with reference to Europe. The same applies to their global ranking. In a study, the World Economic Forum has rated Finland, Sweden and Norway behind Singapore in positions two, three and four of the countries best prepared for the digital challenges of the future. The EU Commission has identified Denmark as a “digital leader” – trailed directly by Norway and Sweden.

Cables laid early even to the remotest corners

What makes the northern countries so strong in terms of bits and bytes? How does their digital expertise



affect everyday life at home and at work? Nobody becomes leader of the standings overnight, neither in sports nor in the world of ICT. There are many reasons why the Nordic countries are in such a good position today, a major one being a close-meshed telephone and broadband cable network. Much earlier than most other countries in the world, the Scandinavians began to establish networks to connect with even the farthest reaches of their countries – and there are plenty of remote places in the rather sparsely populated north of Europe. In Denmark today, according to the Digital Economy and Society Index 2016 (DESI), 92 percent of the entire population have access to a high-speed line with a minimum of 30 Mbps. Norway (80 percent) and Sweden (76 percent) are above the European average (71 percent) as well. In addition, Sweden shines with 99 percent LTE4 coverage. In spite of extremely low cable fees, the Finns tend to prefer cell phones. In the country that's home to former cell phone world market leader Nokia, there are 139 cell phone contracts per 100 citizens, nearly twice as much as the European average. Land lines, if at all, can only be found in offices anymore, particularly in Finland.

Talking about Nokia: The Finns, presumed dead by many, quit the smartphone business, but by acquiring a competitor have become the world's largest supplier of network technologies, relegating their Swedish rival Ericsson to second place. Due to their strong presence in their home countries, Nokia and Ericsson with their more than 100,000 employees have contributed a lot to the population's affinity to technology and innovations. U.S. web pioneer Ajaz Ahmed thinks that the digital pioneering spirit at the Polar Circle is certainly "comparable with the one in Silicon Valley." Driven by similar curiosity and zest for exploration that made their

» *Nokia's comeback gains pace. Lifting spirits in Finland*

Olli Rehn,
Finland's Minister of Economic Affairs

ancestors, the Vikings, set sail for unknown coasts, young northerners embrace new technologies.

The end as a hotbed for something new

Needless to say, Nokia giving up its smartphone business was a blow to the Finnish soul. But: Many of the employees who lost their jobs as a result ventured the leap into self-employment and founded startups. These, too, contribute to the fact that in Finland, today, 6.7 percent of all jobs are in the ICT sector. Not surprisingly, on a European scale, only Sweden (6 percent) can match up to this, the European average being 3.7 percent. Ex-Nokians have since bought back the naming rights of their old company for mobile end devices from Microsoft and are planning to soon start selling smartphones and tablets bearing the Nokia logo. "Nokia's comeback gains pace. Lifting spirits in Finland," said Minister of Economic Affairs Olli Rehn on Twitter, assessing this development. The "old" Nokia on the other hand has found new fields of activities, such as digital medicine applications and cameras for virtual worlds.



Finland is Nokia, and Nokia is Finland – one might think. However, Finnish ICT outfits are also particularly present in the games market. Rovio, a company founded in the Espo suburb of the country's capital in 2003, with “Angry Bird” has landed a worldwide hit that was a chartbuster also as a motion picture. Although the bird fever has notably cooled down and a sequel has not yet been launched, the dream of becoming the 21st Disney continues to exist. Another heavyweight in this scene is games developer Supercell (“Clash of Clans”) from Helsinki that was founded in 2010 and, today, has a market value of several billion euros.

Helsinki also plays host to Slush every year – a type of Woodstock of the startup scene. “The event is currently the universe of the tech scene,” says Niklas Zennström, co-founder of Skype and Atomico. It's not only a place where 2,000 startups meet, but also 800 venture capital firms whose money might propel innovations into the next orbit.



Nokia has survived the end of its smartphone business and subsequently emerged as the world market leader in network technologies. In addition, the Finns have discovered new digital playing fields for medical technology and virtual reality

That the Nordic countries have produced such an active and innovative startup scene is not only due to their enthusiasm for all things digital, but also due to the close-knit social network that catches bold entrepreneurs in case they should occasionally stumble. Another typical aspect in the north of Europe is a society shaped by co-determination and flat hierarchies. “The way in which Nordic companies operate can be linked with the sauna culture,” said Jean-Jerome Schmidt, Head of Marketing at ICT services provider Severalnines, in a report on techradar.com. “Whether you're the CEO of a company or the receptionist, once you're all sitting in a sauna together, barriers fall and everyone is at the same level.” Pär Hedberg, Chairman of Swedish hardware supplier THINGS, adds: “The intern's ideas are given as much respect as the CEO's, and a culture like this fosters genuine innovation.” Not least due to this culture, Sweden has not only produced H&M, Ikea and Volvo, but also global digital success stories like Skype, Spotify, MySQL or “Minecraft.”

Open mind, open data

Across companies, creative interaction is appreciated as well. The Linux operating system of the Finn Linus Torwalds is a prime example of the openmindedness of Nordic ICT companies. Whereas Microsoft and Apple guard the source code of their operating systems like a gold treasure, a worldwide developer and user community keeps improving the functionalities and possible uses of Linux.

Such openness is by far not the exception in the digital north. Neil Sholay, Vice President of Digital, Oracle EMEA, reported having observed how closely startups work together there, creating a very innovative community. A close-up experience of this can be gained in the Kista Science City in the north of Stockholm. More than 1,000 companies of the industry, including big players like Microsoft, IBM and, of course Ericsson, have set up operations in Europe's largest ICT complex. This is where wireless communication standards such as NMT, GSM, EDGE and W-CDMA have been developed.

When it comes to handling data, a certain openness is valued as well. In Finland, for instance, sending a text message is all it takes to identify the owner of a vehicle. The personal incomes of individuals can be viewed by means of just a few mouse clicks as well. When the Google Car drove through Copenhagen, Goteborg or Helsinki to take Streetview pictures it wasn't accompanied by a firestorm of protest, as had been the case in Germany for instance. Is so much data nudism good or bad? Obviously, this is debatable. For Jan Tore Sanner, Norway's Minister for Local Government and Modernization, it's clear: “Access to open public data leads to new services,

entrepreneurship, business development and a more open and democratic society. Giving others access to this data can create added value for the whole society.” Nonetheless, Norwegians basically feel that every individual should be in control of their personal data.

In Denmark’s capital Copenhagen, in collaboration with the Japanese electronics corporation Hitachi, the database platform “City Data Exchange” is currently in the making which, if successful, might also be used in other big cities. It’s intended to bring together all segments of society – authorities as well as citizens and companies – who will have access to the database. Be it statistics about energy consumption or crime rates, environmental data or the current weather forecast, surveys or real-time measurements: the data cloud above Copenhagen is growing. Target group-specific applications – ideally developed by local startups – help analyse the data.

Like Norway’s Minister Sanner, Copenhagen’s Lord Mayor Frank Jensen is convinced that good access

» Access to open public data leads to new services, entrepreneurship, business development and a more open and democratic society. Giving others access to these data can create added value for the whole society

Jan Tore Sanner,
Norway’s Minister for Local Government
and Modernization

to data provides many positive impulses, “which among other things, can create new technological solutions. For instance developing applications to save energy and increase mobility for companies and citizens. Innovative solutions can also help foster growth and create jobs in Copenhagen,” he says.

Investment in research and education

Respective investment in research and education is another factor that plays a role in extending the digital advantage the northern countries have achieved. At the moment, the north of Europe is suffering from a shortage of ICT specialists. One of the reasons being that after the internet bubble at the beginning of the millennium burst, many young people starting college opted for other fields. To avoid such inhibiting shortages of personnel in the future, young people are to be familiarized with the digital worlds early and on a broad base. This is another reason why educational authorities in Scandinavia recently teamed and linked up with New Media Consortium (NMC), a global community of leading universities, colleges, museums and research centers. The objective is to inform school principals and other decision makers in the field of education about the latest technological developments and, in the next step, integrate them into the classroom. In the next five years, it is planned to include cloud applications, the Internet of Things, computer-based simultaneous translation and wearable technologies such as Google Glass, smart-watches, body sensors and even computer games in the curriculum. Even at this juncture, the Scandinavian countries are trailblazers in terms of online learning aids and tests. Notably, universities and ICT firms are closely interlinked. In many cases, these companies set up sites close to the campus or assign employees to teach at the universities. The Kista Science City alone has established teaching positions for 6,800 students at the university and technical university in Stockholm.

An exciting project is supported by the non-profit organization “Ung Företagsamhet” (“young entrepreneurship”) in Sweden, in which high school students between the ages of 16 and 20 years can start a company of their own alongside their classroom work. The reported successes are respectable, indicating that the participants have enhanced their self-confidence, decision making and team skills. In addition, they’re said to be better at problem solving.

The Kista Science City near Stockholm is Europe’s largest ICT complex and closely interlinked with the universities of the Swedish metropolis





Cash money is a dying species in Scandinavia. Instead, people make digital payments using systems such as MobilePay of Danske Bank

The northern countries' affinity to technology is reflected in everyday life as well. Be it shopping, banking, communication with authorities and doctors, or mobility applications: there's hardly another region in the world where everyday needs are being met by online services to an equally great extent. Sweden, the country that, about 350 years ago, was the first to introduce banknotes, is now about to assume another monetary pioneering role: by completely abolishing hard cash. Since 2008, the circulation of hard cash has been cut in half in the kingdom. Getting one's hands on it has meanwhile turned into a real challenge, as more than half of the branch banks have stopped disbursing coins or bills. Getting rid of them again is no mean feat either because not only the Stockholm subway insists on electronic payment. Even at flea markets in the north of Europe, people increasingly make cashless payments – thanks to MobilePay. The

system initiated by the Danish Danske Bank even makes transfers possible from one smartphone to another. Times change, and so does money: cash is no longer king – only if it comes in digital form.



THE AUTHOR

*Üks, kaks, kolm – author **Volker Paulun** can at least count to three in Finnish, having visited Scandinavia on two dozen occasions, mostly for personal but also for professional reasons. One story the native of Schleswig-Holstein remembers particularly well, perhaps because it was free of technology for a change is the report about the wedding of Sweden's Crown Princess Victoria.*

3.7 M

Danes, in other words two thirds of the population, have downloaded the **MobilePay app**. In Norway and Finland, this form of cashless payment by smartphone is being increasingly adopted as well. 70 percent of the users are not customers of the issuing Danske Bank.

800 M

euros are invested by Apple in one of the world's biggest data centers, in Foulum near Viborg – **it's the largest new single investment by a foreign company** ever made in Denmark. The launch is planned for 2017.

50 %

of Norwegian economic growth in 2015 was directly or indirectly attributable to the **ICT sector**.

Source: Telenor

SO WHERE ARE THEY DRIVING?

Whether or not the future will belong to self-driving vehicles has long ceased to be the question, it's only a matter of when. But what markets are autonomous vehicles going to conquer first? Some experts expect threshold countries to be the front runners – an assumption that surprises at first glance and is not unanimously shared.

— by Denis Dilba





— What mobility of tomorrow should ideally look like is clear: preferably powered by electricity, obviously from renewable sources – and in large part autonomous. The reason is that if the rapidly growing conurbations in threshold countries should be quenching their future thirst for mobility with conventionally powered automobiles the Paris Agreement on climate protection that entered into force at the beginning of November 2016 will simply become infeasible. However, such zero-emission, self-driving vehicles would not only improve air quality in the growing megacities in the short term and, in the long term, benefit the climate. Self-driving buses or cars in consolidated fleets for short-range public transportation in the burgeoning big cities could also cause traffic to flow again. Due to more efficient operation, the number of vehicles in the city decreases and streets and roads would no longer be prone to current levels of congestion. Today, traffic jams for miles and miles are the rule.

Pragmatic decisions in threshold countries

But is the assumption realistic that threshold countries are going to directly cover their pent-up transportation needs with the latest technology? Nicolai Müller, an automotive expert with the consulting firm McKinsey & Company, is skeptical in this respect: “The lack of infrastructure is a major impediment for new technologies such as e-mobility and automated driving.” Therefore, it would have to be developed step by step. “In threshold countries, electric cars and self-driving vehicles are going to catch on later than in regions like Europe, the United States or China,” says Müller.

Although Toyota’s technology press spokesman Dirk Breuer essentially shares this view, he also points out an advantage that many threshold countries have: “In contrast to Germany, which is almost over-regulated, decisions in threshold countries are made fast and pragmatically,” says Breuer.

Consequently, some experts feel that it’s entirely possible for autonomous vehicle technology to be implemented faster in threshold countries than in Europe and the United States. “When you think about the infrastructure that’s being created in places like China and

EFFICIENT TECHNOLOGIES FOR THRESHOLD COUNTRIES



Irrespective of the question of whether or not self-driving vehicles are going to spread particularly fast in threshold countries in the future, conventional vehicles are increasingly being registered there as well: reasons enough for Schaeffler to offer efficiency-enhancing solutions in this field too.

Particularly in Asia and Latin America, a major portion of personal transportation needs are covered by mopeds and motorcycles. For them, Schaeffler offers numerous newly developed components such as chain tensioners and tooth chains, starter freewheel systems and specially sealed bearings. These innovations not only reduce friction and wear, but also weight and the required assembly space.

Schaeffler's demo vehicle "Efficient Future Mobility India," for instance, proves that cost-efficient technologies can also reduce CO₂ emissions in the passenger car sector. Electronic clutch management, variable camshaft timing and a thermal management module optimize fuel economy in this case.



OVER \$ 500 M

has been **invested by GM** in ride-sharing service and Uber rival Lyft.

FROM 2021

on, Ford is planning to launch **self-driving taxis** – without steering wheels, brakes and gas pedals.

SOME \$ 60 B

per year could be saved by U.S. insurance companies alone by 2040 due to increasingly **autonomous vehicle traffic** and the resulting decrease in accidents.

Source: KPMG

India, they can actually plan and build for autonomous vehicles, where we are retrofitting everything here in the states," Rebecca Lindland, from the U.S. automotive research company Kelley Blue Book, said in a recent interview.

***China is waiting impatiently,
but the Old World isn't***

People in threshold countries would certainly welcome the new technology, according to a recent

“Automobilbarometer 2016” study of Commerz Finanz GmbH, an institute specializing in loans for cars and other consumer goods. A survey of 8,500 consumers in 15 countries revealed that China at 91, Brazil at 73 and Mexico at 69 percent responded favorably to the question “Would you want to use an autonomous car?” indicating an above-average interest in this forward-thinking technology.

This stands in stark contrast to the countries that play key roles in developing the technology. Approval ratings in Germany are at a mere 44 percent, the United Kingdom at 36 and the United States at 32 reflecting even lower acceptance. These figures prove that the automobile in its most advanced form will probably be adopted much faster in the surveyed threshold countries than elsewhere, write the authors of the Commerz Finanz study. This view is shared by U.S. analyst Lindland, who provides another argument in support of fast adoption, assuming that it would be highly unlikely for people who never owned a car before to miss anything when using a ride-sharing service based on autonomous vehicles. This is exactly what the two U.S. ride-sharing industry giants Uber and Lyft anticipate as well. Both are involved in driving the development of autonomous cars and are now beginning to scour the new markets. Uber, for instance, has been increasing its activities in the African marketplace since last year.

Does autonomous mean cheap driving?

The higher purchasing costs of autonomous vehicles would not affect the users, according to experts. Over the long run, the respective ride-sharing services would recover these costs due the vehicles’ long useful life and cost savings for personnel. Consequently, for most people, it will be far more economical to hail an autonomous car on demand than to own one. This might be another aspect promoting the spreading of self-driving vehicles in threshold countries.

Now, one would think that the cost factor should be a selling point in the western world as well. Researchers from Columbia University in New York have calculated that the price per mile for a taxi ride in New York of about four dollars today could drop to half a dollar as a result of the more economical operation of a self-driving taxi fleet. This means that the average American who travels some 12,000 miles by car would pay 6,000 dollars to cover this distance in a robotic taxi. This would be hard to beat with a privately owned vehicle. Still, in most regions where the traditional automobile has become firmly anchored in people’s lifestyles, the switch to the new technologies can be expected to occur at a slower pace, as habits and traditions inhibit the process of transformation, the Commerz-Finanz study concludes.

However, by 2035 at the latest, autonomous vehicles will have become established around the world – this, at least, predicts the strategy consulting firm Oliver Wyman. At that time, partially and fully automated vehicles could account for 20 to 30 percent of the global vehicle production. So, there’s not much time left to prepare: “For automakers, it’s crucial now to cover the new opportunities of creating value by entering into strategic partnerships while suppliers should concentrate on providing cutting-edge technology at competitive prices,” says Juergen Reiner, an automotive expert at Oliver Wyman. “The most successful players will be anticipating the requirements of the vehicle users, the development of relevant legislation and insurance terms, and offer tailored solutions.”

Cultural knowledge is very important

In this context, Rainer Kurek, CEO of the technology consulting firm Automotive Management Consulting, in Penzberg, Germany, cautions against underrating the regional manufacturers in threshold countries that are still relatively small today. “Knowledge of a country’s cultural background and the resulting customers’ needs is extremely valuable – I venture to doubt that particularly the Chinese manufacturers will remain as unsuccessful as they are today.” In Kurek’s opinion, autonomous cars as well as all other forms of mobility are only going to catch on if the customer’s benefit has been precisely identified for the respective market. Therefore, he feels that communication and cooperation are the two key topics in designing new products for the growing markets in the threshold countries.

“Talking to the people on the ground and understanding them and their needs takes time that we actually don’t have in the light of climate change,” says Kurek. “But that’s the only way it’s going to work – I wouldn’t let someone else tell me what kind of car I need either.”



THE AUTHOR

She could imagine him as a motivational trainer of a special ops police unit, Denis Dilba’s career counselor told him years ago. Or in a UN think tank: in other words, optimum prerequisites for “doing something with media.” So, the man with an engineering degree gave up his career as an automobile developer, completed the German School of Journalism in Munich, founded Fail Better Media GmbH, and went on to write for important scientific publications and websites. For “tomorrow” Dilba also introduces five masterminds of mobility (see p. 28).

THE FUTURE LIVES IN THE CITY

The urbanization of society will have a major influence on our future – the majority of trend researchers are in agreement on this. An extensive study by the consulting firm PwC shows why London, Singapore and Toronto are best prepared for the impending challenges and which major cities have the greatest need to catch up. Three factors that also play a central role in Schaeffler's business strategy are deemed to be crucial in this context: digitalization, a zest for innovation, and mobility.

— by Carsten Paulun

Literal skyscrapers in Shanghai: The Chinese megacity only achieves position 21 in the PwC comparison of cities. It only stands out as a trade fair center and a gateway

— Lian Chen has just turned 32. With his wife, Xiaomeng (29), and his daughter, Laura (9), he recently moved from a village to the megacity Shanghai. He was a farmer with heart and soul, just like his father and his grandfather. Like all parents wishing for their children to have a better life, Lian and Xiaomeng would like life to be a little less laborious than it has been for them. Not that the Chens are complaining about their previous life, but they were lacking prospects, especially for their daughter. Lian now drives a taxi and Xiaomeng works in a textile factory. They're happier now than they used to be, particularly because their daughter has a chance for a better future: a future with an education, healthcare and perhaps a little prosperity.

Risks posed by social imbalance

Millions of people around the globe act like the Chens. They move to the city in search of their very personal fortune and at least a little bit of prosperity. Either of these is increasingly hard to find in rural regions, not to mention medical care, comfort – and yes, equally important – entertainment. This applies to Africa as well as to the south of Italy or rural regions in East Germany.

The major rural exodus confronts big cities like Paris, New York, Rio de Janeiro, Shanghai, Johannesburg or Sydney with massive challenges. Economic and social components alike have to be taken into account and as many people as possible be given opportunities to

participate in success – otherwise there's a threat of social imbalances and disastrous wrongs like in Lagos, the city that was ranked at the very bottom of the study (see page 27). Poverty is a big problem in many cities, including Jakarta. And wherever there's a lack of money, there's a lack of education. "40 percent of our young population cannot afford to go to school," says Pak Ahok, the governor of Indonesia's capital. Traffic is another major issue. Because in the past the city was unable to provide low-cost public transportation, there are 13 million motorcycles and 4.5 million cars in the streets, resulting in air pollution and gridlocks – in more ways than one. A city is like a transmission. One gear meshes with the other one.

A fruitful, multifaceted innovation culture is an important provider of impulses. Therefore, city fathers are also responsible for cultivating it by providing appropriate overall conditions, demands the Italian architect and urbanization expert Carlo Ratti from the renowned Massachusetts Institute of Technology (MIT). Innovations generate jobs, and jobs generate money. Money pays for schools, roads, social services and local public transportation – in other words quality of life. And this quality of life attracts new innovation drivers to the city. This, in a nutshell, describes urban prosperity, for which London, Singapore and Toronto, the three top players of the current PwC ranking, are showcases. —



LONDON STRONG FRONT RUNNER WITH TRANSIT WEAKNESSES

#1

London is the front runner in this year's PwC ranking, and in the eyes of the authors of the study it does a lot of things right and doesn't rest on its laurels. The UK capital is a **source of innovation and skilled personnel**. Furthermore, the metropolis on the Thames has the greatest economic clout and shines as a trade fair location and international gateway. Its "Technology read-

iness" also receives a very good rating (second place after Singapore).

Good but not very good is London's position in the area of urban mobility and infrastructure – an important factor as a location for both the economy and the citizens. Even today, **London records 31 million rides per day** – by bike, car or local public transportation. And London is planning to invest in all of these areas. In

new bicycle speedway construction projects, park & ride facilities and train lines as well as in the expansion and upgrading of existing train connections and roads. Furthermore, digitalization is intended to help make mobility more efficient. According to the annual report of London Transit, 8,200 developers have used the Commission's data for developing some 500 apps which 40 percent of Londoners use to get around their

The Tube opened in 1863 is the world's oldest subway and London's most important transit system



city faster and better. This benefits the environment as well, which is another weakness of London.

A major issue with local transit is that it's **too expensive – like many things in the city**. Another negative not to be underrated: exorbitantly high cost of living is no tasty bait when fishing for talent. Another factor that might lead to a brain drain is Brexit, which is not generally taken into account in the PwC study. If Brexit should erect barriers, which might



for example make access to the labor market more difficult, a lot of innovation prowess could be lost. Charles Wiles, owner of app developer Zzish and a Brexit opponent, said on LinkedIn that he'd been working in the tech sector in London for 20 years, for large companies like Google and Toshiba as well as for start-ups, and that **attracting talent from all parts of the world**, but particularly from Europe, was a **crucial factor of success** without which the companies would have major problems or even fail.

Population 2016 8,500,000
Pop. forecast 2040 10,400,000
Area 1,572 km²
Founded 50 AD
Admission to all national museums has been free since 2001



Education and innovation, Gateway, Economic clout



Cost, Transportation and infrastructure, Sustainability and environment



THE STUDY

For more than 14 years, the consulting firm PricewaterhouseCoopers (PwC) has been surveying selected big cities around the world in the “Cities of Opportunity” study. Every two years, 15,000 employees compile the key data of selected cities and prepare an extensive ranking.

The current study from 2016 compares 30 major cities: from Amsterdam to Toronto, from Sydney to Johannesburg. The chart below shows the top 15 plus the bottom-placed Lagos. The study analyzes 67 diverse criteria grouped into the ten categories below:



The complete study as a PDF

- Intellectual capital and innovation
- Sustainability and the natural environment
- Technology readiness
- Demographics and livability
- City gateway
- Economic clout
- Transportation and infrastructure
- Ease of doing business
- Health, safety and security
- Cost

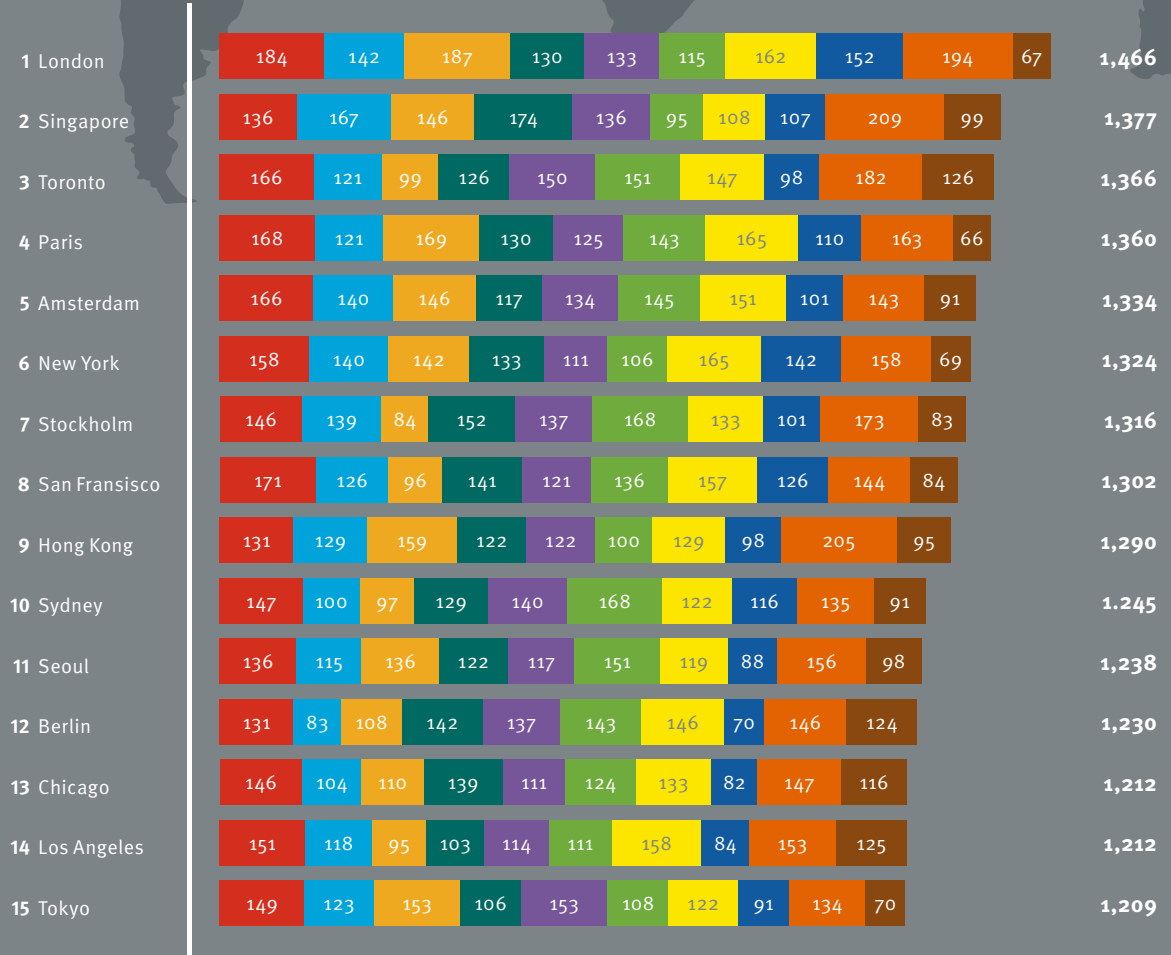

SINGAPORE RICH AND RESERVED

#2

Singapore is different, different to London, different to Toronto. Singapore has sweltering heat. **Singapore is cramped**, more cramped than almost any other metropolis in the world. Even though land reclamation projects have increased the land area by nearly 50 percent in the last 50 years, there are 7,654 inhabitants per square kilometer – twice as much as in Berlin. What distinguishes Singapore from other major cities as well is that the **city state is rich** and as efficiently structured as a corporation. The population is affluent too. Nearly 200,000 dollar millionaires live in Singapore, putting the city among the top ten in terms of per capita income.

However, there are some downsides as well. Many **cheap workers from neighboring countries** who to some extent are exploited like slaves there. Plus, the idea of democracy is not very strong in the state with a single-party system. Strict laws and rigorous punishment keep citizens in line, so the crime rate is low. Companies on the other hand enjoy above-average freedom to do business and, like the citizens, profit from low taxes – two other strengths, according to the PwC study.



A lot of money from the healthy state coffers flows into the areas of transportation and traffic. **Singapore's port is the world's second-largest** after Shanghai, with half of the global petroleum trade taking place here. Also in enviable condition are the streets – which are relatively ungested. For one because Singapore in 1975 was the first city around the globe to introduce a city toll and for the other because even a small car costs as much as a luxury sedan does elsewhere. The alternatives are to catch one of the 28,000 surprisingly cheap taxis or use public transportation. The expansion of the bike path network is intended to make bicycles more attractive.

The communications network for fast internet is already in very good shape, which earns the city plus points in the “technological readiness” category. However, the city doesn't capitalize enough on this forte. Rigorously structured **Singapore ails in terms of innovations**. The influx of fresh brainpower is blocked by high immigration hurdles. These barriers could also exacerbate Singapore's demographic issues. If the city fails to counteract the trend, the share of over-65-year-olds will double by 2030.

Population 2016 5,500,000

Pop. forecast 2040 6,200,000

Area 718 km²

Founded 7th century AD, independent city state since 1965

62 islands form the national territory



Technology readiness, Transportation and infrastructure, Ease of doing business



Sustainability and environment, Population structure, Intellectual capital and innovations

Good prospects: From the Infinity Pool of the Marina Bay Sands hotel a view of the well-positioned gateway and economic metropolis of Singapore can be enjoyed

Population 2016 2,600,000
Pop. forecast 2040 3,300,000
Area 630 km²
Founded 1793
Peter Ustinov: "Toronto is like New York run by the Swiss"



Healthcare and Security, Cost, Sustainability and environment, Education and innovation



Gateway, Transportation and infrastructure, Economic clout

View of the Toronto skyline from Lake Ontario. The 550 meter high CN Tower, once the world's tallest building, stands out as a landmark

TORONTO THE UNRECOGNIZED QUANTITY

#3

London shines as an innovation driver and global economic engine, Singapore as a technology and business promoter. So, what about third-placed Toronto? According to the PwC study, the Canadian city with a population of 2.6 million doesn't achieve an absolutely top score in any category. But the decisive aspect is that **Toronto is an all-rounder**, scoring many individual top results and not showing any weak areas. The multi-cultural melting pot (50% of the population was born abroad) is North America's second-most important finance center after New York and ranks among the top ten in the world.

Toronto is in a strong position in the **pioneering high-tech sectors** of bio science and information and communications technology (ICT) as well.

Plus, one in three employees has a college degree. So it's no wonder that the "Intelligent Communities Forum" regularly ranks Toronto among the "World's most Intelligent Cities," which is supposed to stay that way. By 2019, the number of ICT specialists alone is expected to increase by 52,700 people to nearly a quarter of a million.

Many of these jobs could be filled by young people from the city. Toronto, not without pride, refers to having been named the **world's most youth-friendly city** in the "Youthfulcities" study in 2014. Much of what makes Toronto so attractive finds favor particularly with young people: innovative and creative jobs, good transit, fast and affordable internet and digital services, an

attractive waterfront location and a lively music, film and cultural scene.

In spite of enviably positive overall conditions, Toronto has managed to take second place in the cost category – referring to costs of living and labor costs – in the PwC study, right behind Johannesburg.

Still, there's a lot that speaks for moving to Toronto. 100,000 people do so every year. Many newcomers are attracted to the exurbs. The "Greater Toronto Area" is expected to grow from 6.6 **to over 9.4 million people by 2040**. This poses new challenges to traffic planners as well because currently only the road network to the center is state-of-the-art while connections to the outskirts are just patchwork.



MEGATREND URBANIZATION

AFRICA AND ASIA IN FRONT

97.6% of all Japanese are expected to be living in cities by 2050 – the world’s absolute top mark. But the global average manifests the trend toward urbanization as well: 66.5% of all people around the globe will be living in a city by the middle of the century, according to projections of the United Nations. While urbanization is decreasing in the largest part of the industrialized world it is significantly increasing in threshold and developing countries. Asia’s and Africa’s share in urban growth is 90 percent. China is expected to have reached a level of urbanization of 75 percent by 2050. For comparison: In 1950, it amounted to 12%. India’s metropolis Delhi – in 1950, not represented among the world’s 20 top cities – will be the second-biggest city with a population of over 30 million behind Tokyo in 2050.

The world’s 20 biggest cities (population in millions)

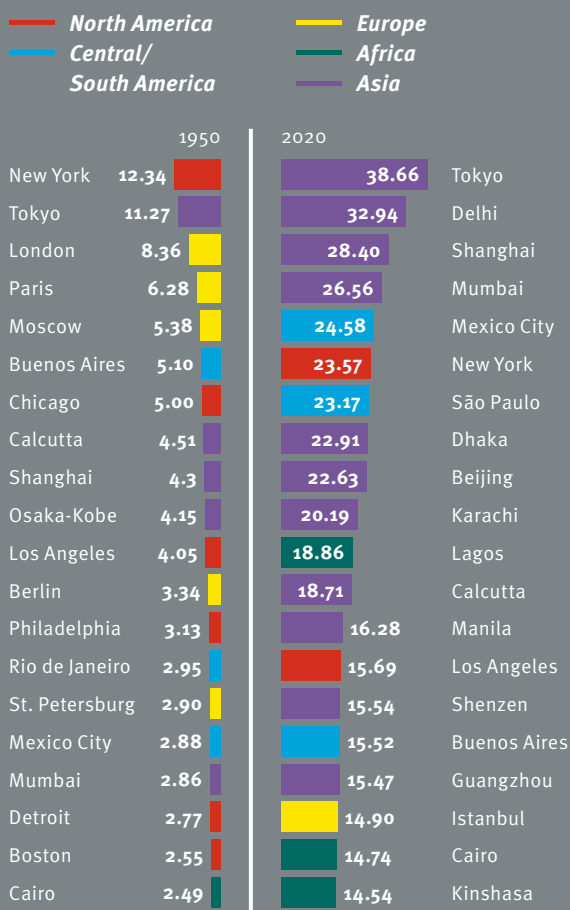

Forecast: United Nations

» Cities ought to be built in the countryside, for the air is better there

Henri Bonaventure Monnier

GIGA METROPOLITAN REGION



Over 100 million people live in the Pearl River Delta with the megacities of Guangzhou, Hong Kong, Shenzhen, Dongguan, Foshan, Jiangmen, Huizhou, Zhongshan and Zhuhai in an area that roughly equates to the German state of Baden-Württemberg.

14 M

people live in Los Angeles, enjoying four times as much space as the 18 million inhabitants of Mumbai – a typical example of the crowded conditions in poorer megacities.

MEGATREND URBANIZATION

CITIES AS ECONOMIC ENGINES

The economies of some megacities have by now reached the same dimensions of those of individual countries. That's why economists, in addition to the gross domestic product (GDP), are measuring the gross metropolitan product (GMP). The GMP of the Chinese metropolis Guangzhou with a population of 11 million, at 271 billion dollars, is larger than the GDP of Finland (270 billion). However, Guangzhou has twice as many inhabitants.

The GMP top 5 in 2030 in billion US dollars

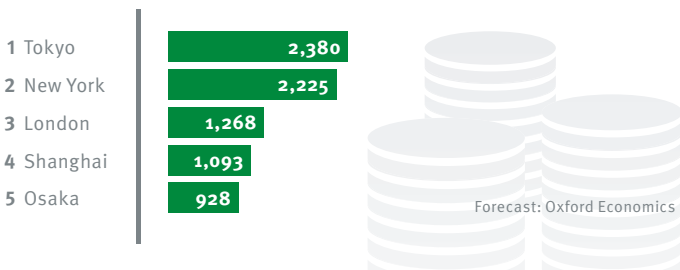

MOBILITY IN THE CITIES

Distances covered in big cities shown by the type of transportation used in 2013 (in percent)

- Motorized individual transportation
- Public transportation
- Bicycles
- Pedestrians
- Others

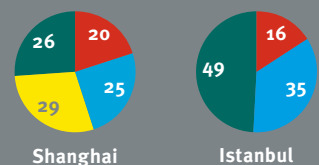
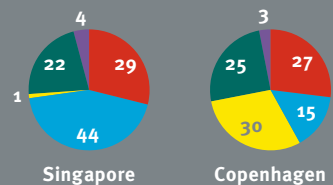
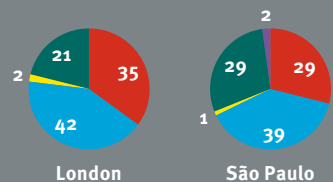
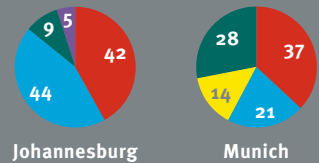
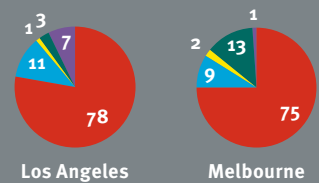

Source: MAN/TU Munich

MACROTREND “GREENING”

A stable, broad middle class is the backbone of a healthy city. And the people belonging to it have different values marked by increasingly strong environmental awareness. This should also be reflected in urban planning. Gray cities should become green cities. The northern Italian industrial center Milan has accomplished this transformation. 320 hectares of green space and 140 kilometers of bike paths have been created within the city. Passenger cars are not allowed in the center during the day. The architectural symbol of this transformation is the “bosco verticale” (“vertical forest”). The residential complex vegetated with thousands of trees, perennials and shrub was recognized as the world’s most innovative high-rise building in 2014.



Source: MAN/TU Munich



In all walks of life, Lagos presents itself as chaotic as in this picture

LAGOS AT THE BOTTOM WITH NO PROSPECT OF HOPE

Nigeria is a rich country, but the population is poor. The profits from the abundant oil fields **seep away in corruption**. In addition, Africa's most populous country suffers from terrorism. Lagos, with a population of 15 million, is the biggest city – and the loser in the PwC study. And this defeat is a home-made one because the best economic and employment growth in this comparison, showing rates of 6.5 and 6.2 percent, proves the city's potential. But the city does not invest enough, particularly in education and knowledge. Internet

connections, freely accessible libraries and universities or legal certainty hardly exist. There's no other city surveyed in this study in which it's more difficult to protect one's intellectual property. A health system is practically non-existent and **diseases spread rapidly**. Senior citizens and their families are left to their own devices. No other city has more violence and crime, plus the city offers nothing to the majority of the population

to make it a livable place: no public transit, no affordable entertainment, no parks. Lagos is equally **unattractive for people and companies**.

University lecturers, skilled personnel, engineers – they're all leaving the city. Only the oil entices international companies to go to Lagos. Export revenues from oil have been leading to a continual rise in prices and cost of living. That's why Lagos has become one of Africa's most expensive cities.



THE MASTERMINDS OF MOBILITY

Traffic jams, stress, parking space shortage, CO₂ emissions, fine-dust pollution and accidents – these are the negative focal points of road traffic in 2016. Scientists and industry experts predict that this picture will change in less than ten years' time. From our smartphones, we're going to hail self-driving electric vehicles that will take us to our destination while we relax, read a newspaper, check our emails or watch a movie. There'll be no need for parking these zero-emission vehicles that only need to stop at a battery charging station, their next passengers already waiting for a ride. We don't know whether this scenario will actually come true, but we do know that mobility for tomorrow will be different from the one for today. "tomorrow" presents five digital masterminds whose visions are giving important impetus – as well as ruffling some feathers.

— by Denis Dilba

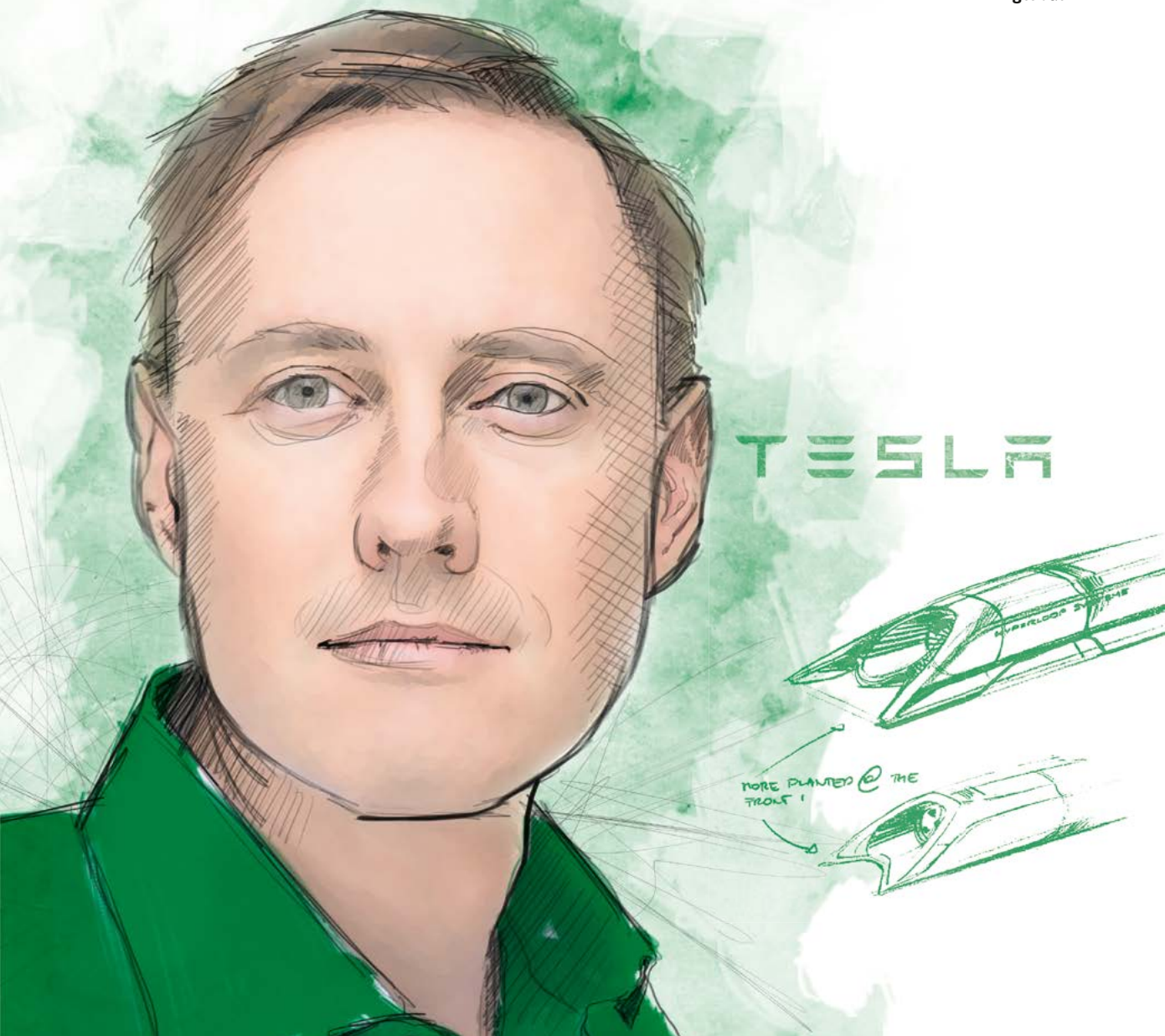

THE VISIONARY

Elon Musk could have retired in comfort at the mere age of 28. Expressed in euros, he received about 22 million from the sale of Zip2 Corporation, a company he'd started and built together with his brother. The online service made it possible for newspapers to publish regional maps and address lists on the internet. Albeit a life of leisure would have been alien to the nature of Musk, who was born in Pretoria, South Africa, in 1971. What followed has been a breathtaking career that has lasted to this day: PayPal, SpaceX, Tesla Motors. Musk's electric sports cars have stirred up the entire automotive industry. Without Tesla, said GM Vice Chairman Bob Lutz, there wouldn't have been the Chevy Volt. "If some Silicon Valley start-up can solve this equation, no one is going to tell me anymore that it's unfeasible." Musk, who recently presented an electric SUV, the Model X, now intends to conquer the mass market with the smaller and lower-priced Model 3 starting in 2018. Whether or not Musk, who studied economics and physics in Pennsylvania, was involved in engineering it, as he'd been in the first Tesla model, has not been revealed. After all, his other visionary mobility projects such as SpaceX, a 100-passenger transportation module for space travel to Mars, or the Hyperloop supersonic train are time-consuming as well. However, it can be assumed that he's capable of mastering such a balancing act, as Musk is purported to work between 80 and 100 hours per week.

THE FIGHTER

Travis Cordell Kalanick is a man who's intimately familiar with extremes. His first start-up, Scour, a file sharing service, was confronted with a lawsuit by the music industry for the record amount of some 250 billion U.S. dollars. Scour filed for bankruptcy protection, Kalanick went on to start other businesses, and today is CEO of Uber. Worth 63 billion U.S. dollars, Uber has been rated as the most valuable start-up of all time. In the next few years, Kalanick, reputed to be the most aggressive man in Silicon Valley, will have to prove if this is justified. Clearly, though, the mobility services provider that has won worldwide acclaim by customers for its convenience and usefulness, and is demonized by the taxi industry, is one of the most innovative companies founded in modern history and disruptive in the best sense of the word startup. At the push of a button, the online platform puts passengers in touch with chauffeured rental cars or people driving their privately owned vehicles. The latter service in particular has been the subject of legal controversy in many countries due to the lack of insurance for passengers. However, Kalanick, who was born in Los Angeles in 1976 and dropped out of college, is not only battling an "asshole named Taxi," as he's been known to refer to his business rival. The entire automotive industry has long been roiled by him as well, as Uber is working on self-driving taxis. "Our intention is to make Uber so efficient, cars so highly utilized that for most people it is cheaper than owning a car."



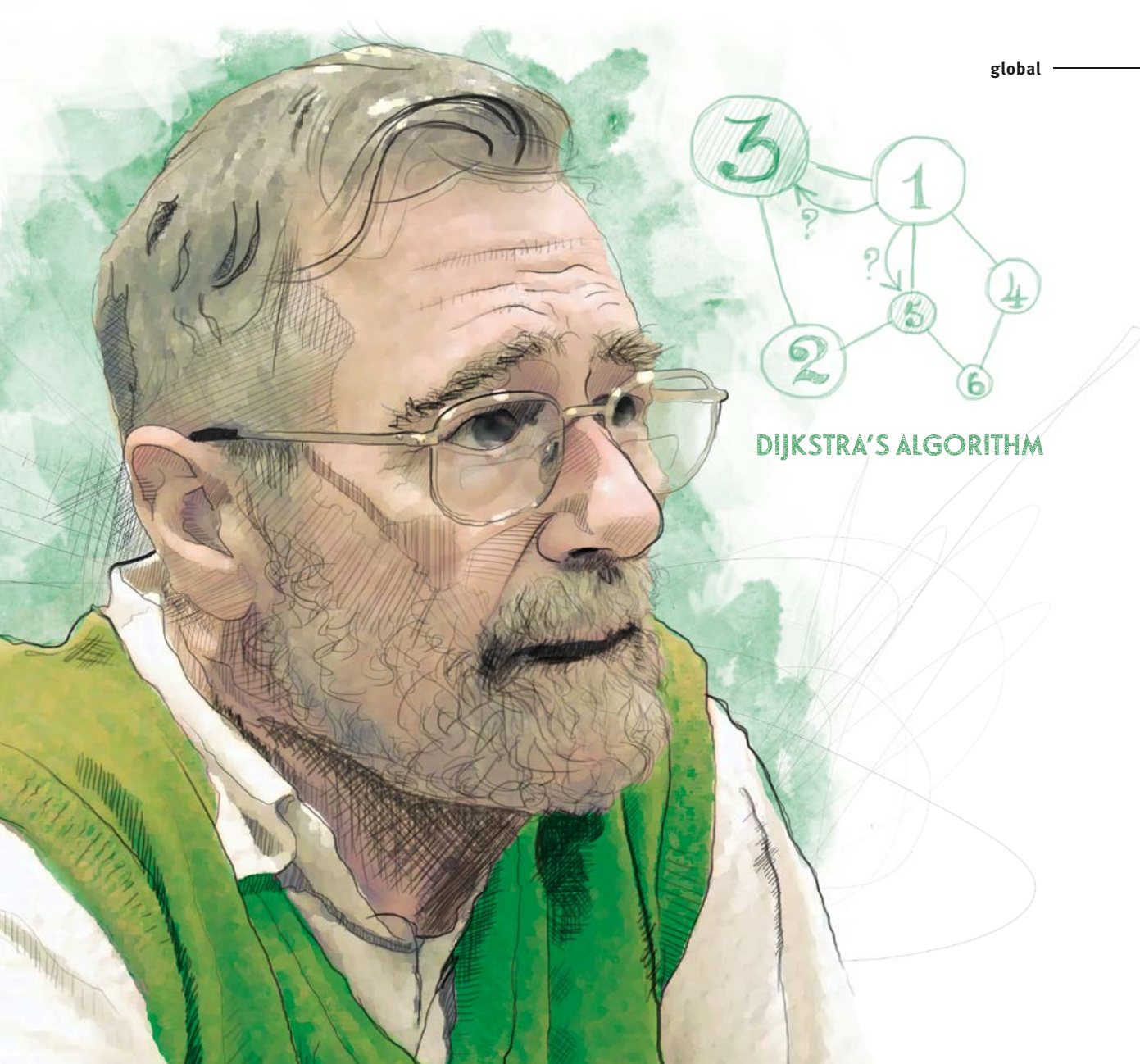

DIJKSTRA'S ALGORITHM

THE PIONEER

Most non-computer scientists have never heard of the Dutchman **Edsger Wybe Dijkstra**, who died in 2002. Now this may well be regarded as an injustice of history because on a daily basis, all of us work with his development, Dijkstra's algorithm, better known as the shortest path algorithm. It calculates the most fuel-efficient route in GPS navigation systems, finds the shortest walking distance to the nearest coffee shop on Google Maps, or shows the fastest train connection to a desired destination in an app. The Dijkstra algorithm is also used to optimize the way data packets travel through the internet and to accelerate the frame rate in computer games. As a result, it can be assumed to be one of the most frequently used algorithms in the world. The efficiency at which the algorithm operates matches that of its development by the programming pioneer who was born in Rotterdam in 1930: during a coffee break on a shopping tour with his fiancée in 1956 – in the space of 20 minutes and without a pen and a piece of paper. Dijkstra, who professed to be a maverick, initially taught good programming at TU Eindhoven and subsequently at the University of Texas at Austin. This, in Dijkstra's opinion, absolutely included the need for structure in code. He predicted at an early stage that programs would soon reach unmanageably large dimensions. This is another reason why the winner of the Turing Award – the unofficial Nobel Prize for computer science – was far ahead of his time.

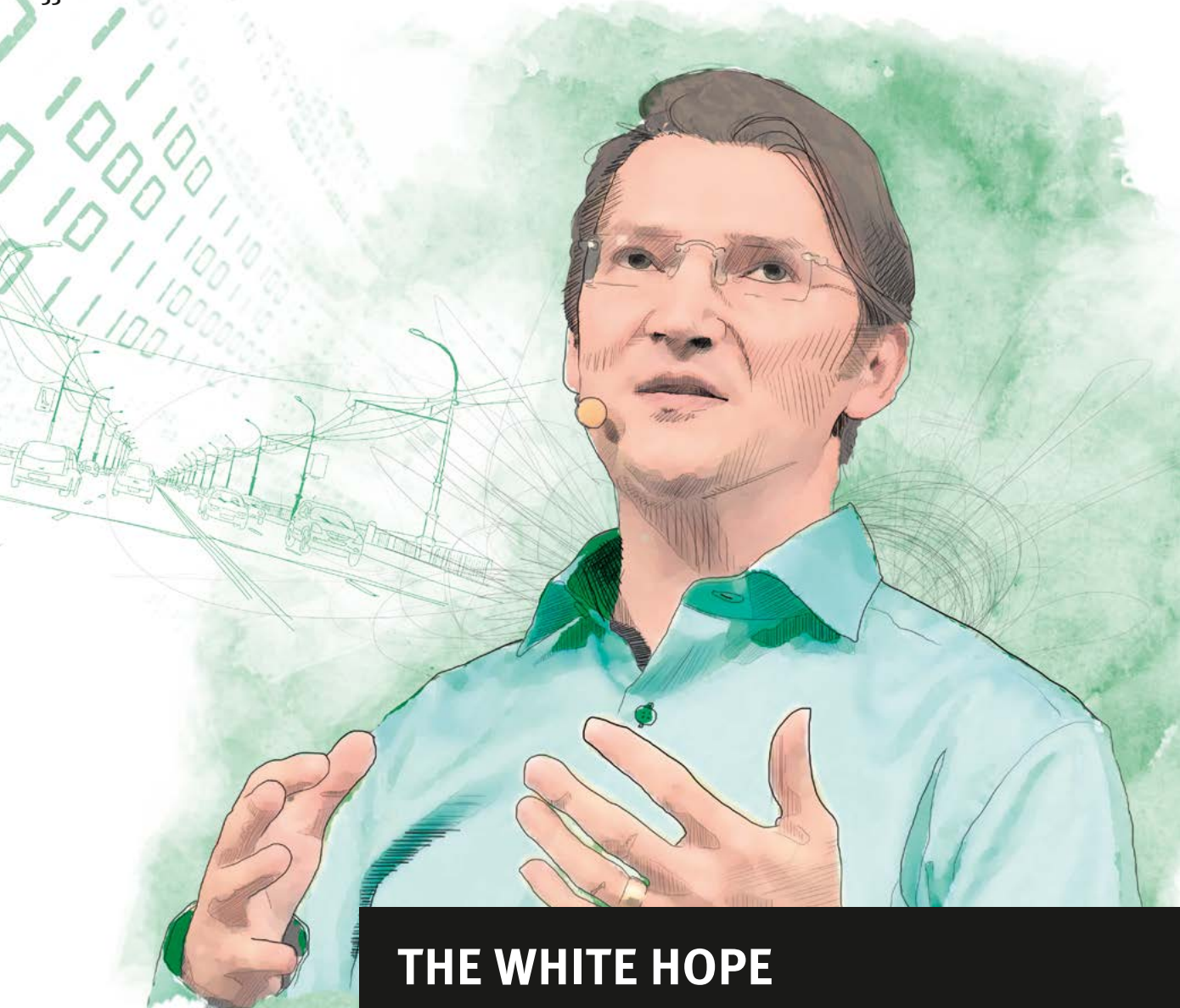

THE WHITE HOPE

Anyone giving up a job with Apple in California to move to Wolfsburg is either forced to do so, enticed by a very large amount of money – or motivated by personal conviction. In the case of **Johann Jungwirth**, who has been the Volkswagen Group's new Chief Digital Officer (CDO) since November 2015, the latter aspect predominates – even though the family man and father of three can be assumed to make a good living in this new role which he took on in the midst of the VW emissions scandal investigations. Jungwirth, who was born in Romania in 1973, is sure that this presents an opportunity because “chances for receptiveness to change are maximized in a situation like this.” And he knows that this is exactly what he’s going to need in the years ahead, as electric mobility, self-driving cars and the trend toward Shared Mobility are up and coming. “For about 130 years, we’ve primarily been seeing evolutionary steps in automotive engineering. Now, we’re about to make an exponential leap,” says Jungwirth. Volkswagen will be transforming into a provider of “mobility on demand.” Jungwirth, who started his career by studying electrical engineering at DHBW Stuttgart, is driven by no less than democratization of the automobile. Everyone, without exception, is supposed to be able to benefit from this. “JJ,” as he likes to be called by his colleagues, is already acting as a role model for change, driving to work every morning in an E-Golf. “The car feels great,” he says, “For me, there’s no going back to the old ways.”

THE SUPER BRAIN

Even before winning the 2005 Darpa Grand Challenge, **Sebastian Thrun** was a high-flyer, majoring in three subjects up to completing a Vordiplom (intermediate examination), earning a PhD “summa cum laude” in computer science and statistics at age 28, and becoming an assistant professor at Stanford University. But the scientist only became world famous after taking the converted VW Touareg “Stanley” across the finish line in first place in the race for robotic vehicles. Google’s founder Larry Page commissioned Thrun to establish the secret research lab Google X where, among other things, he was in charge of designing the Street View cars. With that, Thrun, who was born in Solingen, Germany, in 1967, laid the foundation for the Google Maps service, a key technology for the autonomous Google Car that was developed by X-Labs under Thrun’s watch as well. The technology is going to make road traffic safer, says Thrun: “I’m already looking forward to the days when future generations will look back and say how ridiculous it was for people to drive cars themselves.” However, the autonomous car is to be developed to production level by others. Thrun, who says he learned “to think bigger” at Google, stepped down from his professorship in 2012 and co-founded the online educational institution Udacity. The U.S. for-profit organization is valued at one billion U.S. dollars. Thrun is not the only one to predict growth of the digital educational market, as the Bertelsmann media group invested in the company in 2014 and significantly increased its stake in 2015.



GRANDPA'S CALCULATOR

— Well into the 1970s, the slide rule was the standard instrument used by natural scientists and engineers. At school, in professional education or on the job, it was regarded as a handy and reliable everyday computing device. Sticking out of a shirt pocket as a status symbol, it was also meant to show that the wearer had a certain intellectual capacity. Building on the logarithms of the Scot John Napier in 1594, the Englishman Edmund Gunter created the first wooden rule with logarithmic scales in 1620. Only the slide rule, though, subsequently made it possible to engineer steam and combustion engines. In the 20th century, some 40 million slide rules were produced – from wood, aluminum, celluloids and plastics. They also helped develop the pocket calculator – which eventually replaced the slide rule in the 1970s. With that, digitization found its way into everyday life. But the pocket calculator has long been supplanted as well. Every smartphone today has a calculator app and highly complex computing operations are performed by increasingly fast supercomputers (see chart). —



» The laws of nature are written in the language of mathematics Galileo Galilei

in motion

Innovations in the course of time

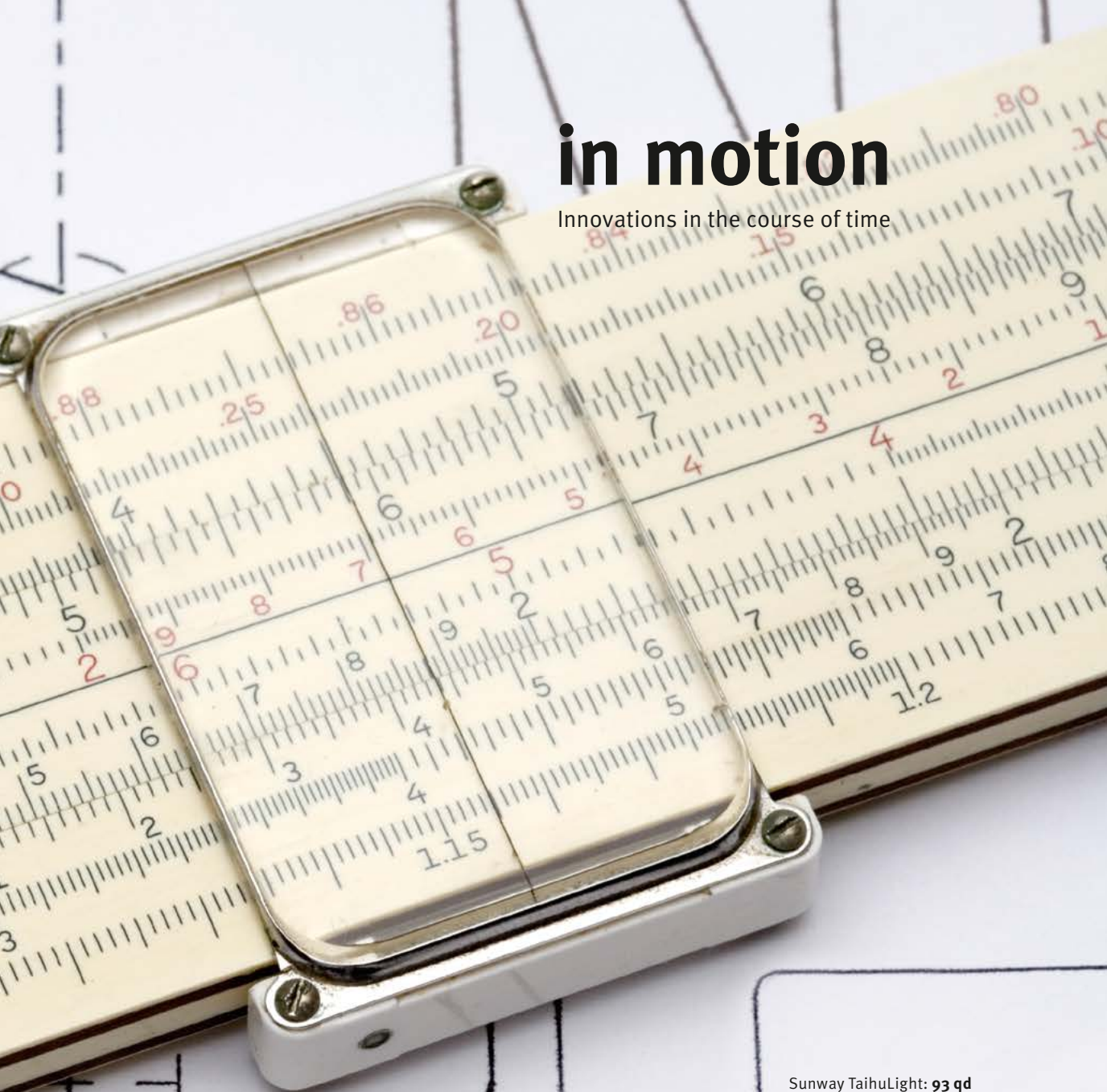

THE FASTEST COMPUTERS IN THEIR DAY

The world's first digital computer, the Zuse Z3, managed 5.3 computing operations per second, surpassed by the 17.5 quadrillion-fold performance of the fastest super-computer today, the Chinese Sunway TaihuLight.

— Speed at time of commissioning

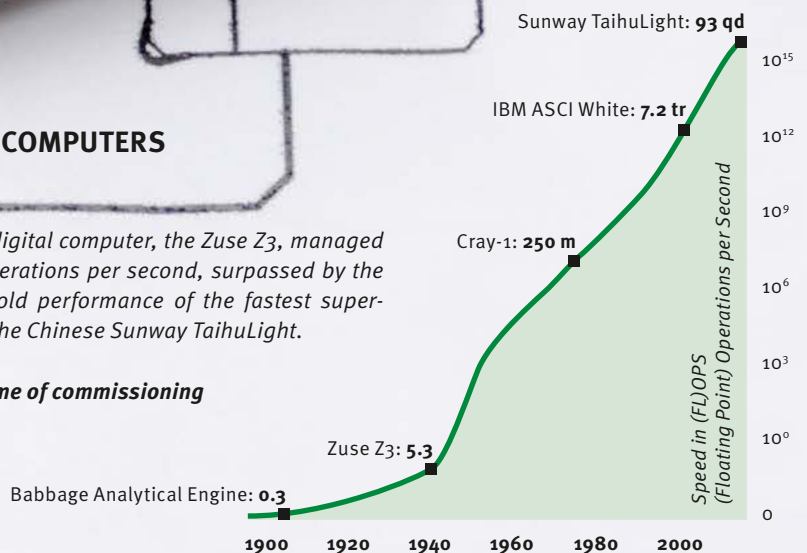

CONTROL UNIT





In the past, the steering wheels of race cars hardly differed from those of production vehicles. Today, they look as though they've come straight out of an airplane. Here's a peek into four cockpits.

1987 AUDI COUPÉ QUATTRO

RALLY



Armin Schwarz “The steering wheel of the Audi in which I became German rally champion in 1987 hardly differed from that of a production car. It was a simple two-spoke sports steering wheel. Due to a red marker at the top of the steering wheel rim you could always keep an eye on the steering angle. There were no buttons on the steering wheel. As prescribed in Group A at that time,

we’d use the stalks of the production cars for a lot of functions such as the windshield wiper or turn signals. The instrument panel had a number of indicators for engine speed and various temperatures the driver had to watch. This has been significantly reduced on today’s rally cars. The driver now only has an rpm indicator and a lamp showing when it’s time to shift. The other instruments have since migrated to the co-driver’s domain so that the drivers can fully concentrate on driving.”

As the rally version of the Audi Coupé quattro was prepared according to Group A regulations, it largely corresponded to the production vehicle



2016 AUDI RS 5 DTM



- | | | |
|----------------------------------------|------------------------------------|--------------------------|
| 1 DRS | 5 Drink system | 9 Speed limiter pit lane |
| 2 Team radio | 6 Windshield wiper | 10 Upshifting |
| 3 Parking brake for starting procedure | 7 Speed limiter full course yellow | 11 Transmission neutral |
| 4 Downshifting | 8 Engine start | 12 Electronics reset |



A typical characteristic of DTM cars like the Audi RS 5 DTM is the control carbon fiber monocoque prescribed by the regulations, which the driver sits in



Mike Rockenfeller “Although a DTM steering wheel does have a few buttons, it’s a far cry from being as complicated as a wheel, say, in the WEC. There’s one for team radio and the pit lane speed limiter. Plus, the most important buttons include those for the parking brake we use

during the starting procedure, for starting the engine and for idling. At the center of the wheel, we often have a track map to simplify our communication with the race

engineer. Behind the steering wheel, there are three paddles. We use the right-hand one to shift into higher and the left-hand one to shift into lower gear – both without operating the clutch. With the upper paddle we can activate the drag reduction system DRS which causes the rear wing to be lowered for more top speed, resulting in better overtaking opportunities.”

2016 ABT SCHAEFFLER FE02



- 1 Screen change on display
- 2 Adjustment to remaining laps
- 3 Activation of FanBoost (additional power)
- 4 Activation of selected functions
- 5 Downshifting

- 6 Team radio
- 7 Transmission neutral
- 8 Recuperation
- 9 Brake balance selector
- 10 Discretionary function
- 11 Adjustment to remaining laps

- 12 Reverse gear
- 13 Upshifting
- 14 Speed limiter full course yellow
- 15 Speed limiter pit lane
- 16 Output adjustment selector



Like in any single-seater, space conditions in the cockpits of the all-electric Formula E race cars are tight

Lucas di Grassi “Our steering wheel almost resembles a game console. It has countless buttons, wheels and paddles, plus a colorful display. The steering wheel itself is identical for all teams – but we can individually select the functions for all the keys and buttons. Every team, and sometimes even every driver, has their own ideas and wishes in this respect. In addition to all the standard functions that exist anywhere in racing, it’s obviously important for us to keep an eye on energy consumption. For this purpose, the display indicates the respective state of charge and we can manually adjust the number of laps in order to have the maximum amount of energy per lap recalculated. The paddle for activating the FanBoost is another feature unique to Formula E.”



More motorsport in “tomorrow” starting on page 86: trackside data analysis and its significance for the development of road-going products

2016 PORSCHE 919 HYBRID

WEC

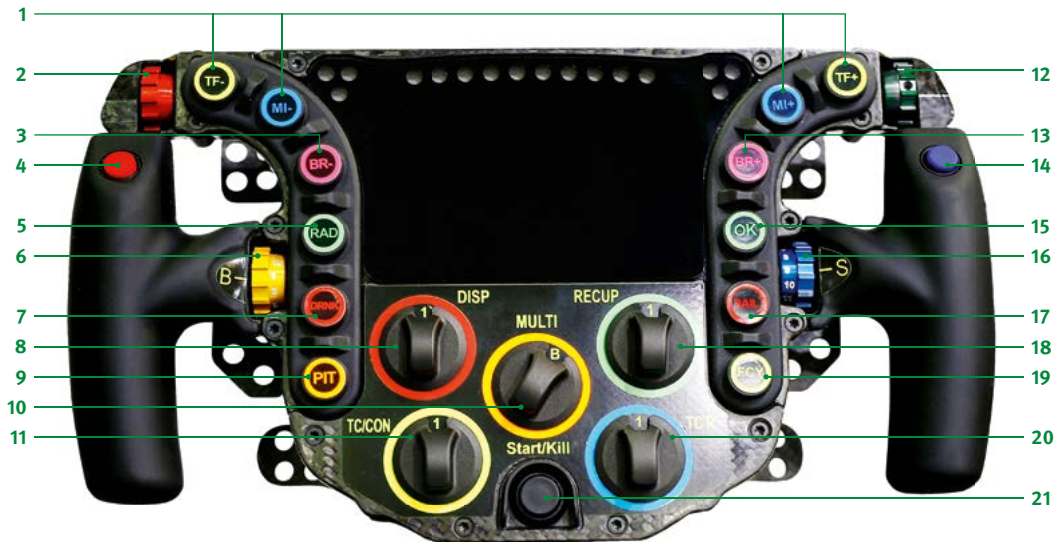

- 1 Engine and hybrid settings
- 2 Selection step of ten
- 3 Brake balance
- 4 Boost
- 5 Team radio
- 6 Amount of boost energy
- 7 Drink system
- 8 Selection displayed information

- 9 Speed limiter pit lane
- 10 Multifunctional switch
- 11 Traction control
- 12 Selection single digit
- 13 Brake balance
- 14 Headlight flasher
- 15 Confirmation of selected functions

- 16 Strategy mode
- 17 Sailing mode
- 18 Energy recovery mode
- 19 Speed limiter full course yellow
- 20 Traction control
- 21 Combustion engine on/off



Timo Bernhard “The steering wheel of the Porsche 919 Hybrid in which I compete in the FIA WEC and in which I became world champion in 2015 has nearly 30 buttons, switches and paddles in total, for a wide range of functions. In addition, we look at a large display indicating the current gear engaged, the lap times and various data, etc. There are buttons for simple functions such as team radio or for the pit lane speed limiter that prevents us from driving faster than the maximum 60 km/h permitted. The rotary switches, for instance, allow us to change the engine’s mapping, in other words the tuning of

the engine’s electronics, or the delivery of the additional output of more than 400 hp regenerated by the hybrid system. Located behind the steering wheel are paddles for the clutches, plus one each for shifting into higher and lower gear.”



With its numerous controls the cockpit of the Porsche 919 Hybrid resembles that of an airplane

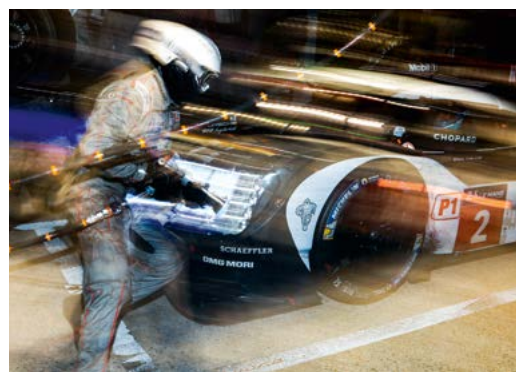

SCAN TO WATCH VIDEO

Modern motorsport steering wheels explained by race drivers.

I LIKE IT



No, not everything was better in the old days. No apps, no GPS, no Netflix. Instead, we'd unsuccessfully try to hail a taxi, be driven to despair by studying maps or watching what was offered on television. So, let's enjoy the things that have changed instead of fearing them!

— by *Wiebke Brauer*

— Remember that ugly sound when the player in the car would eat the cassette and spit out the magnetic tape in a zigzag fold, squealing while shredding and chewing plastic? That grinding noise while we'd try to roll up the tape again using the tip of a pencil? The 56-k modem that would dial in, followed by the dial tone and then the melodious sequence of the phone number, the distorted whirring and creaking ending in a rhythmic buzz? The crackling noise while tuning into our very favorite radio station that only yesterday was on the air crystal clear and had apparently since moved to Mars? Yes, there are definitely sounds the world no longer needs. How lucky we are: Gone are the days when we were struggling with unlabeled diskettes, scratched music CDs, dried up correcting fluid and ink eraser. While nostalgic feelings can warm our hearts, they also blur our view of the seemingly golden age of the analog. So, let's enjoy digitization, albeit with a grain of salt.

We only grasp the things we grasp

Well first, we should perhaps explain what exactly is meant by digitization and digitalization and why it

seems dangerous to us. Sascha Lobo, an author, blogger, and “owner of a successful hairstyle” as he’s purported to have once said himself, described digitization as “virtualization and automation,” adding that it meant “the shifting of major processes into the digital sphere where they are executed by algorithms.” Digital sphere, now that sounds abstract and mysterious. Which takes us to the real issue: We only grasp the things we grasp. The virtual, though, remains unfathomable and magical. Sascha Lobo writes: “The magical digitalism, however, becomes a twofold problem for society: on the one hand, when this digital superstition is the result of ignorance and on the other, when it stems from hubris, the over-confidence of those who are in the know.” And in nothing flat, we’re sure that machines influence the outcome of elections, that there’s no truth in news but only spin – and that the internet causes us to perceive the world in distorted fashion. In this vein, American business journalist Nicholas Carr warned that relying on Google Maps means to view the world through the eyes of Google and using Facebook pressing one’s social contacts through the filter of a company and its algorithms. Strictly speaking, he warned, we trust black boxes whose inner workings are concealed to us as a business





We've gone on to live pretty happily – in spite of the internet, or perhaps because of it!

secret. Are we other-directed by algorithms and black boxes – and: what was that again? Eerie to be sure!

Who wants the national anthem and a test pattern

Now before we toss our iPhones out the window we should stop and think for a moment about all the things we have digitization to thank for and that we've gone on to live pretty happily – in spite of the internet, or perhaps because of it. Just think about all the things that have happened in the entertainment industry! Remember the days when you'd mark the shows you were planning to watch with a pencil in your printed TV guide?

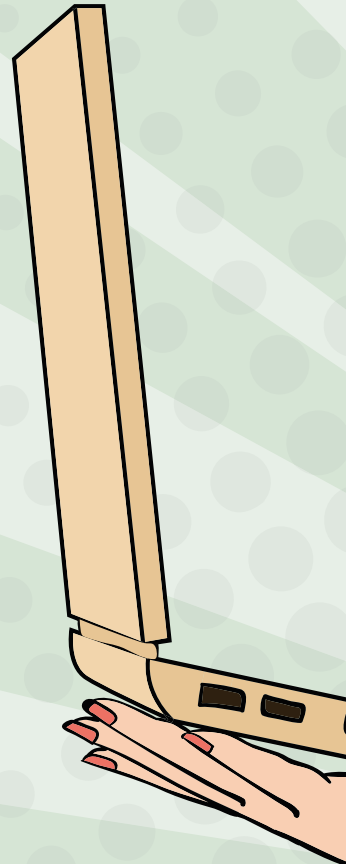

If you missed them – tough luck! And, honestly, who'd like to be limited to just three channels as we used to be in the "old days" in Germany and, when they went off the air at night, be treated to the national anthem and a test pattern? Instead, we can watch whatever we like whenever we like: an Israeli soap in the morning, a Danish documentary at noon and an iconic American movie at night. Gone are the days when we'd press our nose against the window of a video rental shop because it was closed. Or, talking about music: There are tales of people going to a record store singing a song they'd heard on the radio but didn't catch its title – yet wanting to buy a single of it. Now, today we may find this funny, but back then it wasn't necessarily so.

Today, we download the "Shazam" app, hold our phone against the speaker, let the technology recognize the song – and then listen to it on Spotify or Tidal. Whether or not the streaming services sufficiently pay the artists is anyone's guess, but it's safe to assume that digitalization motivates people to listen to music, not just on the ten records collecting dust on a shelf, but brand new recordings being suggested to us. And how did the novelist Umberto Eco appropriately put it? "Just like jazz didn't extinguish classical music the internet will not destroy book culture." We listen, read and write like there was no tomorrow, thanks to digitization. It's hard to imagine the days without smartphones. Mothers would try to untangle the telephone cable in the hallway,



»» *When more and more of the things in our lives take place in the digital world, the analog, not the digital, acquires a new quality*

Andre Wilkens,
Author

fathers heroically struggle with maps in the car and children be glued to the tube. Okay, today, their faces are shining in the light-blue light of their smartphones. We're all hooked on our phones like junkies, caught in the permanent maelstrom of the digital. Not many of us can still concentrate on reading a book for two hours. A Microsoft study published in 2015 says that the average attention span has deteriorated by more than 30 percent since the turn of the millennium, now amounting to 8 seconds. The one of a goldfish is 9 nine seconds. The solution: "digital detox" camps in which permanently accessible people simply go offline for a while and re-discover their analog self.

Online connects – even real people

But there are easier ways as well. Networks have been established on the internet that put neighbors in touch with each other in the real world. Instead of

"Liking" something one of our 432 "friends" have posted on Facebook we have the option, for instance, to click www.nextdoor.com in order to get to know people living in our neighborhood, borrowing tools from each other, recommending a good dentist or arranging for babysitters. And lo and behold: the tone is friendly and we practice common courtesy. After all, we might be standing in line together single-file at the supermarket cash register the next day. Andre Wilkens, the author of a book titled "Analog ist das neue Bio" ("Analog is the new organic") agrees, stating in an interview that, as more and more of the things in our lives take place in the digital world, the analog, not the digitally networked, acquires a new quality. The man is right.

While we may express disapproval of the internet due to the risk of alienation and isolation it harbors, it's also safe to state that it brings people together. New friendships will hardly be formed as a result of Facebook, but old ones can certainly be cultivated by using the social network, be it that by posting a picture we feel closer to our old friends or by quickly writing them a message. Now whether a "single" will fall in love every eleven minutes on a popular dating platform, who knows? But, certainly, we're no longer standing around on an over-30's night and friends are no longer desperately trying to play matchmaker for the last single in their circle using flimsy arguments ("You know, Philipp's a real fan of 'Game of Thrones,' you should meet him). Thank you very much, but online dating seems like the better option.

FINGERS TURN INTO DIGITS

Of very analog origin in the modern sense is the word digital as it stems from the adjective digitalis – "belonging to the finger" – which has been derived from the Latin word digitus meaning "finger." What is meant here is one of the ten fingers that were needed for counting and are still needed today – for instance in case of a power outage. In Latin, digitus also means "digit" – because of the finger's capacity to be used for counting. In this meaning, the word then also found its way into the English language. So, when the word became a German loanword that was adopted from English only in the 20th century, interest was no longer centered on the finger, but on the meaning "converted into digits" that was derived from "digit."

Source: wissen.de



Digitalization not only changes our love lives, but also our habits as consumers. While for a long time on-line shopping was believed to be destroying local retail, small factories and shops we'd otherwise never know existed are putting together websites on which we can buy their hand-made goods. Another good one: On the www.kiezkaufhaus.de website in Wiesbaden/Germany, customers can place online orders for products sold by local retailers at the regular price, with free, same-day

deliveries made on zero-emission e-bikes. So we can see that technological progress is transforming the world in all walks of life – from culture to communication to commerce. And, mind you, not just in negative ways – that should make us reflect on whether our anxiety might not perhaps stem from a fear of change and look at the benefits which the shift to the virtual has brought us. Now, that doesn't mean we need to post our enthusiasm on Facebook right away.



THE STORY OF THE FUTURE

Stay hungry. Stay foolish. Think different. This mindset made Steve Jobs an epitome of the modern innovator. Apple's legendary CEO had no regard for traditional business models. With the 2007 iPhone he not only revolutionized the way we make phone calls, but also how we listen to music, take pictures, move in social networks and much more. Everything takes place within a networked and mobile world – and, from the perspective of the respective provider, preferably within the same digital eco-system. Never before have disruptions been faster, never before have time-tested business models been discarded more rigorously than today – also in the realm of mobility.

— by Dr. Joachim Becker



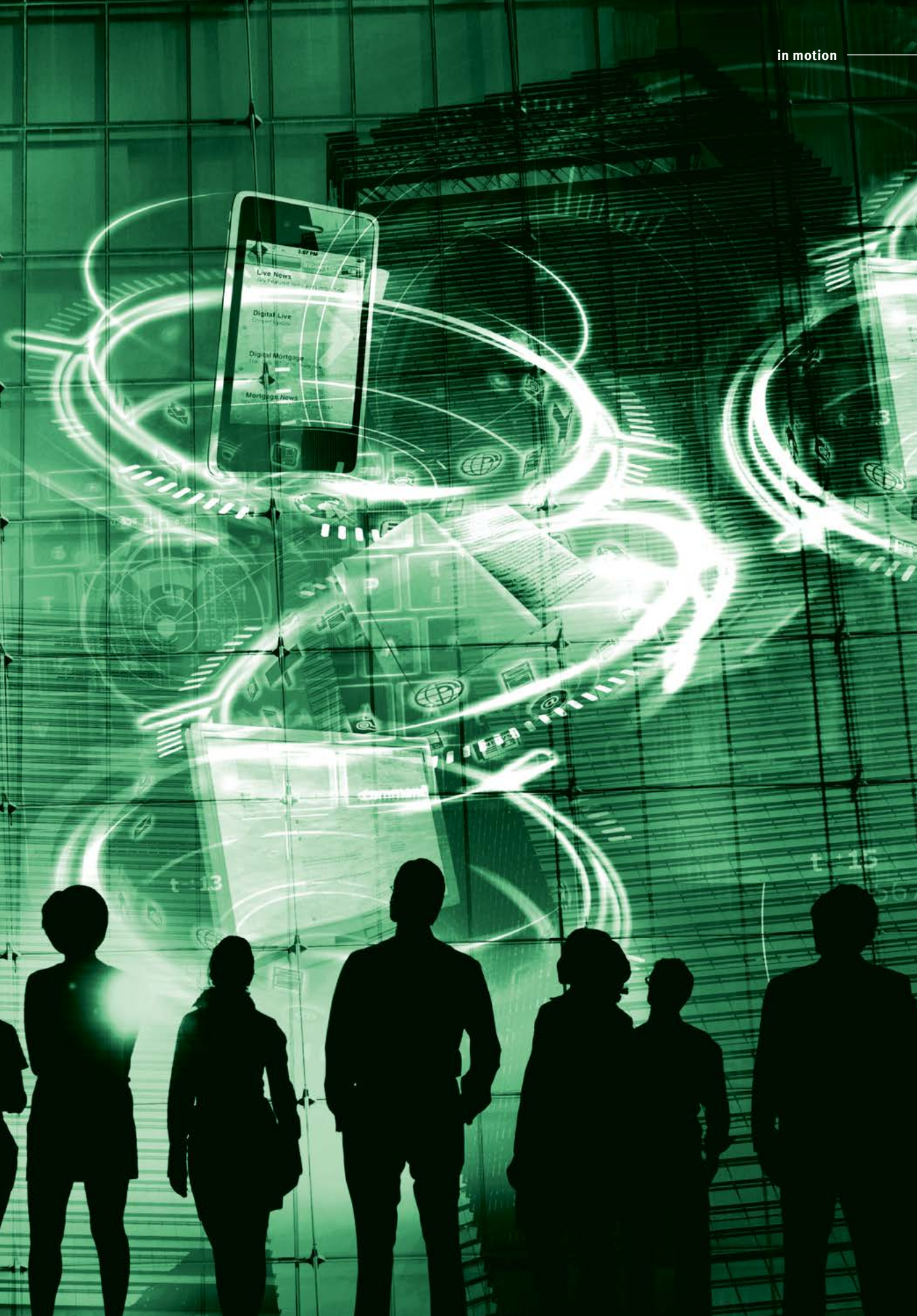

— The good old analogous days when a technological transformation would still take decades: In 1950, railroads were traveled almost exclusively by steam locomotives. 25 years later – on their 150th anniversary – these fire-breathing dinosaurs had practically become extinct. In 2036, the automobile will be 150 years old as well. If John Zimmer ends up being right, passenger cars the way we know them today will continue to crowd our streets and roads in large numbers, but for the founder of the U.S. ride-hailing service Lyft, the “third transportation revolution” is around the corner nonetheless.

Grasp of the wheel to become obsolete

Lyft is planning to put the first self-driving taxis on the road in 2017. One or two years later, the pilot program of pre-programmed routes is to be expanded to variable ones. As early as in 2021, robots are planned as chauffeurs for the majority of Lyft rides. “Private car ownership will go the way of the DVD by 2025,” John Zimmer expects: overtaken by technological progress. His visions have at least convinced General Motors. At the beginning of 2016, the company invested 500 million dollars in the California startup. Ford, as well, is developing autonomous cars that shed steering wheels and pedals as unnecessary ballast.

For German car buyers, all this is still a long way away. On average, they don’t expect driving robots to hit the market before 2029, according to an Ipsos survey. Many consumers picture automated driving as a form of expanded assistance system. Only few can imagine that it might be more convenient to use autonomous taxis in cities than personally owning a car. However, alarm bells have been set off in the automakers’ boardrooms. “None of the major steam locomotive manufacturers survived the transformation in rail transportation and is still in the market as an independent manufacturer! This is not going to happen to us!” Daimler’s CEO Dieter Zetsche proclaimed five years ago. The auto bosses are aware of the risk of possibly being degraded to the level of mere hardware suppliers by new mobility providers and have begun to counter this threat. Yet in spite of this spirit to break

»» *Digital disruption is real, is happening now, and is fundamentally changing the way organizations will compete in decades to come. There has never been time of greater promise, or greater peril. Those that don’t transform now will quickly face mass extinction*

Doug Connor,
Global Vice President for Digital Transformation at SAP

62 %

of oil & gas industry decision makers are planning to **intensify investments in digital technologies** in the next three to five years.

Source: Accenture Strategy

233 B

dollars is the expected volume of the total **“Digital Health”** market by 2020, thus more than doubling. Mobile health solutions (“mHealth”) featuring new mobile wireless communication solutions, apps and services will have a major impact, but smart clothing to monitor vital signs is being developed as well.

Source: Arthur D. Little

19 Trillion

dollars is the projected business volume to be generated by the **“Internet of Everything”** (IoE) – that interlinks people, processes, data and things – by 2020.

Source: Cisco

5 B

dollars by private investors are managed by the Betterment investment service – using a **computer as a fund manager**. The digitized investment program has quintupled its volume in the past year and a half, which is still relatively little compared with the estimated 20 trillion dollars being managed in the US in traditional ways. But the popularity of “Robo-Advice,” as the algorithm-based “consulting service” is referred to, is growing.

Source: Betterment

DIGITAL DISRUPTION

Digitalization transforms and, in fact, displaces existing products and industries. No sector is invulnerable to this disruptive development. According to the Swiss business school IMD, the technology sector – not surprisingly – is, and will continue to be, most severely affected by the vortex of digital disruption (see graphic below).

Many other sectors, such as media, retail, finance, telecommunications and travel, have already passed through the digital transformation process in large parts. Others, particularly the pharmaceutical industry that is still in its infancy in terms of digitalization, are still facing it.



BOTTOMED OUT?

One of the sectors that have already gone through digital disruption in major ways is the music industry. Up until the turn of the millennium, it was strictly heading in one direction: uphill, with sales peaking at 14 billion dollars in the US alone. Then, file sharing platforms like Napster caused the first massive decline. Disruption

intensified when YouTube hit the market. Today, low-cost or even free digital download and streaming offers have almost completely relegated previously high-margin products such as LPs and CDs, etc. to the collectors' and connoisseurs' niche.

Source: Goldman Sachs/RIAA



1.14 T

photos aggregated around the world, were taken in 2016 – more than ever before: a vast majority of them **not being captured by actual cameras** but by smartphones that can immediately disseminate the pictures. **Every day, 1.6 billion photos are sent via WhatsApp** alone. **Kodak** is a well-known victim of digital disruption in the photo industry. In 1996, the U.S. company was the world's fourth-valuable brand, trailing Disney, Coca-Cola and McDonald's, according to marketing analyst Interbrand. 16 years later, Kodak filed for bankruptcy.

new ground, there's one thing that shouldn't be forgotten. As late as in 2040, two thirds of all passenger cars – be they self-driving or not – will still have a conventional IC engine on board. This, at least, is predicted by a number of studies.

This look at the automotive sector provides further proof that the development of digital business models is no longer limited to the internet. In the early days of the World Wide Web, digitalization primarily affected retail and media. Print media have been suffering a decline in circulation ever since because they're competing with online portals offering information free of charge. The sales costs in many areas of the retail sector have dramatically dropped as well, as producers, sellers and consumers can contact each other directly on the internet. Even the food retail business is beginning to gradually migrate to the web.

Old powers, new variables

About ten years ago (coinciding with the launch of Facebook), the second stage of the internet economy was rung in, with platforms in an increasingly large number of sectors inserting themselves between the

manufacturers and their customers. As the digital providers require comparatively small or no physical resources they've been recording rapid growth and, with their high profit margins, wreaking havoc on traditional business models. "Uber, the world's largest taxi company owns no vehicles, Facebook, the world's most popular media owner creates no content, Alibaba, the world's most valuable retailer has no inventory and Airbnb, the world's largest accommodation provider owns no real estate," says network expert Tom Goodwin of Havas Media.

Agile companies can displace established market leaders faster than ever before because they're able to offer their customers better quality, swifter service or a lower price for their services. They're assisted by new technologies such as cloud computing, mobile or social media which will continue to drive change in the future. The Internet of Things, artificial intelligence and learning machines are going to expand these digital base technologies even further. In the not-too-distant future, we'll hardly be able to imagine life without voice-based digital assistants. Within the next decade, purely analogous driving of an automobile might become a nostalgic pastime – like taking a tour on a train pulled by a steam locomotive today.

“THE PROBLEM IS **NOT TECHNOLOGY,** BUT THE WAY PEOPLE FEEL ABOUT IT”

Shiftschool is Germany’s first academy for digital transformation. Instead of theoretical knowledge, the school primarily teaches the practical art of culture change.

“Transformers” – that’s what Tina and Tobias Burkhardt call themselves. Last year, they founded Shiftschool in Nuremberg, for companies that intend to actively shape digital transformation rather than just suffering it. Examples, obviously, are the startups in Silicon Valley. Many of them have experienced rapid growth not (only) with hardware but, above all, with digital business ideas. In spite of sales in the range of billions and five-digit headcounts, companies such as Google, Facebook, Netflix and Tesla have remained highly dynamic. They drive new technology at such a rapid pace that competitors can hardly follow suit. That’s why executive board members in the German automotive industry periodically go on pilgrimages to California, particularly Daimler’s CEO Dieter Zetsche. Most recently without a coat and tie, he’s been endeavoring to infuse the company with greater entrepreneurial spirit: less hierarchical business etiquette and more willingness to take risks and to learn in the process of trying out new business models.

“Transformation is frequently frustrated by lack of communication within a company and is also affected by a lot of emotions,” Tobias Burkhardt is convinced: “New things should not be developed in seclusion according to a fixed technology road map, but need to be centered on the customer.” That’s easier said than done. New digital trends are developing at a breathtaking pace and “visibility” (in other words the foreseeable development) amounts

to a maximum of twelve months ahead. There’s no doubt in Burkhardt’s mind that “Conventional market research no longer works because customers don’t know yet what they’d soon like to have.” In the future, this might apply to the mobility sector as well because an abundance of new sharing models will make private car ownership appear increasingly unattractive, particularly to people living in cities.

“I consider forecasts for the future very dangerous, but it’s clear that the pace of change is likely to accelerate further,” says Tobias Burkhardt. “The future course has to be set now while continuing to drive the old sales model. This is the classic innovator’s dilemma.” Particularly automotive corporations with their long development cycles and model lifecycles are struggling with

“short-term” changes. After all, automated driving, which is being announced in many places, is not only a technological innovation, but also enables countless new business models, robot taxis being a case in point. They combine many new technologies, including voice and image recognition, which have essentially been known for decades.

“Technological change often takes place incrementally. Following a relatively slow start, it’s suddenly ready for many applications,” says Burkhardt. Crucial in this context is the right combination of several technologies that could subsequently trigger exponential growth, as in the case of Apple’s iPhone and currently with digital assistants such as Amazon’s Alexa, Apple’s Siri or Google Home – plus, in the near future, with automated driving.



“Transformers” – that’s what Tobias and Tina Burkhardt call themselves. Their Shiftschool helps companies actively shape digital transformation instead of just suffering it

A LONG LINE(AGE)

Electric mobility is not an invention of the new digital age. The early cars, as far back as 100 years ago, were running on electric power. Automakers have been experimenting with energy from batteries ever since – but only today, it has realistic chances again of mobilizing people.

— by Roland Löwisch

MILESTONES OF ELECTRIC MOBILITY

1834

The American Thomas Davenport presents the first electric vehicle in 1835, albeit only as a model. The Werner Siemens Company ups the ante in 1879 with the first electric locomotive deemed to be fit for field use. The picture shows a PRR DD1 built in 1911. Its two electric motors already deliver remarkable output of 2,000 hp.



1881

This trike – two small wheels on the right and a large one on the left – is deemed the “primeval” electric automobile. Its constructor, Gustave Trouvé, achieves 12 km/h (7,5 mph) with it in 1881, a leisurely pace from today’s perspective.



— When Thomas Davenport, a blacksmith from Vermont, plays with his model train nobody laughs. Although none of the observers realizes that his rail car humming away on a circular track with a diameter of about one meter is going to revolutionize the world, the Patent Office recognizes its importance. Davenport has built the first electric vehicle. Subsequently, in 1837, the blacksmith is awarded the world's first patent for an electric motor. Ever since then, engineers have been pondering the question of how electricity can move people – long before the advent of the IC engine. But why has electricity as a source of propulsion for automobiles not been able to catch on to this day?

The battery: a continuing issue

The main reason is that the amount of energy that can be stored is still less than optimal, although the history of batteries dates as far back as around 1800. That's when Alessandro Volta builds the first functional battery, the Voltaic Pile. The Italian physicist stacks zinc and copper discs on top of each other, separated by pieces of cardboard soaked in a saline solution. In 1859, the Frenchman Gaston Raymond Planté invents the rechargeable lead-acid battery – which makes “modern” electric vehicles possible. However, a few more years would pass before the “primeval electric vehicle” learns how to roll on wheels. In 1881, the time has come. Its constructor, Gustave Trouvé, achieves 12 km/h (7.5 mph) with it, a leisurely pace from today's perspective.

When in 1882 the Austrian electrical engineer Nikola Tesla invents the AC induction motor, electricity seems to be the breakthrough mobility solution. This belief is shared in America as well where, starting in 1890, William Morrison builds the first electric vehicle in appreciable numbers. Six years later, his competitor Andrew Lawrence Riker demonstrates the capabilities of early battery-powered race cars on winning the first U.S. circuit auto race against gasoline- and steam-powered rivals. In Europe, at the end of the 19th century, the contest about the fastest electric automobile begins as well. On January 17, 1899, the Belgian race driver Camille Jenatzy reaches a respectable speed of 66.66 km/h (41.42 mph) in the electric CGA Dogcart vehicle. The continual rivalry with Gaston de Chasseloup-Laubat culminates in Jenatzy's “Jamais Contenté” (“The Never Satisfied”) in which he covers a distance of one kilometer (0.62 miles) from a flying start at a racing speed of 105.88 km/h (65.79 mph). Thus, for the first time ever, a car and driver are faster than 100 km/h (62.14 mph) – a world record.

The disadvantages of batteries – low energy density, high weight, costly production, short life and vulnerability to mechanical shock – lead to the invention of the first hybrid vehicles as early as around the turn of the century. In the Pieper Voiturette from Liège, Belgium, the gasoline engine charges the battery for the

1899



Hybrid pioneer: The Pieper Voiturette from Liège, Belgium, is the first vehicle in which an IC engine charges the battery for the electric drive motor. The picture shows a model from 1900.

1899



E power advantage: The “Jamais Contenté” (“The Never Satisfied”) that reaches 105.88 km/h (65.79 mph) is the world's first car to break the 100-km/h (62 mph) mark.

electric drive motor. An absolute novelty is showcased at the World Exhibition in Paris in 1900: the Lohner Porsche “Semper Vivus” constructed a year earlier. It was developed by Ferdinand Porsche as the chief engineer – with two wheel hub motors installed in the front wheels. On special request, Porsche subsequently equips a version with four wheel hub motors – the first passenger car with four-wheel drive. Two years later, under Porsche’s guidance, hybrid vehicles using Daimler gasoline engines are created and named “Mixte.”

Now all of this sounds like electricity experiencing inexorable success – and in fact, around the turn of the century, about 40 percent of the total of some 4,000 cars in the United States run on electric power (an equal number on steam and only 22 percent on gasoline). Between 1896 and 1939, 565 brands of electric vehicles are registered around the globe.

However, almost simultaneously, various factors ushered in the decline of electric cars, Ransom Eli Olds being the first case in point. In 1901, the American starts building the “Curved Dash” – giving the starting signal for the mass production of automobiles using IC engines, with the main argument of those advocating gasoline, back then and today, being their considerably larger range. In addition, the price of oil in the United States hitting rock bottom spawns filling stations around every corner.

Batteries on the other hand prove to be vulnerable. Cars with practically unsprung full-rubber tires cause the energy accumulators to crumble and inflated tires excessively suffer from the massive weight of the batteries. The electric starter for IC engines as an important gain in comfort, invented by Charles F. Kettering in 1911, is another nail in the coffin of electric vehicles.

80 years of stagnation

All electric vehicle experiments between those days and about 1990 reflect great efforts, but are nonetheless short-lived. The Peugeot VLV (“voiturette légère de ville”/“light small city car”) from 1941 – not least due to World War II – is chanceless, 377 of these vehicles being built until 1945. But even the oil crisis in the 1970s or constantly rising gasoline prices do not get the electric vehicle rolling with lasting effects. The 43.5-hp BMW 1602 Elektro for the 1972 Olympics or the subsequent evolution, the 325iX with an electric motor from 1985, are but mere attempts. In 1971, energy utility RWE, with its subsidiary, “Gesellschaft für elektrischen Straßenverkehr” (“Association for Electric Road Traffic – GES), attempts to provide electricity with new momentum. As a result, scheduled service of the world’s first battery-powered bus line commences in Mönchengladbach in 1974. In the United States, GM invests more than 20 million dollars in e-mobility research and in Germany VW builds a few electric vehicles based on the Golf I and II. However, all of these projects are a flash in the pan.

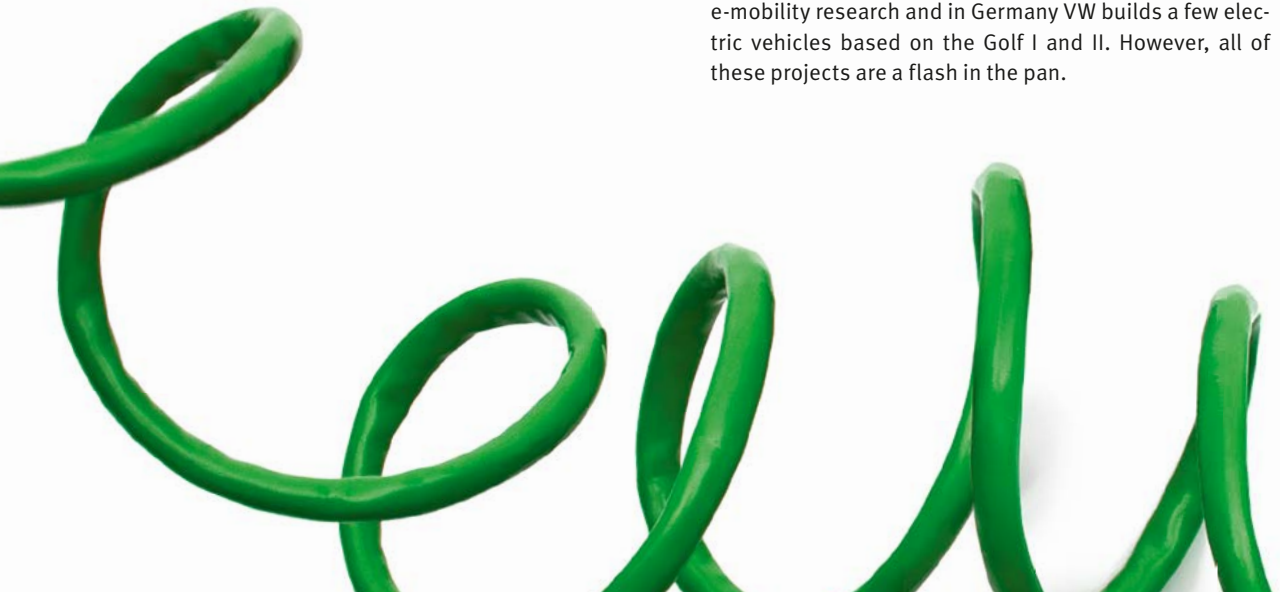

1900

The Lohner Porsche “Semper Vivus” built a year earlier is a star at the Paris World Exhibition. Its technological highlights: wheel hub motors subsequently upgraded to create the world’s first four-wheel-drive vehicle (pictured). A hybrid variant (“Mixte”) is constructed as well.



1907

Detroit Electric launches its first electric vehicle. In the 1910s, the company sells up to 2,000 cars per year, making it the first volume manufacturer of electric vehicles. With a top speed of 32 km/h (19.9 mph) and a range of up to 340 km (211 miles) the vehicles are perfectly fit for everyday use.



Finally, the Clean Air Act passed in the United States in 1990 gives the idea of electricity a new boost. American environmental agencies require automakers to progressively offer zero-emission vehicles (albeit, the hard rules are subsequently softened again). In 1991, BMW showcases the prototype of the all-electric E1 at the Frankfurt International Motor Show and the “Zebra” prototype of the Mercedes A-Class is an electric vehicle as well. PSA Peugeot/Citroën builds some 10,000 units of the electric Saxo, Berlingo, 106 and Partner models. In Germany, on the island of Rügen, 60 electric vehicles from five different manufacturers using various battery systems are road-tested in 1992. In 1996, Audi builds the “duo III,” arguably Europe’s first production hybrid car, which sells for 60,000 deutschmarks. It’s an Audi A4 with a 90-hp liter TDI engine combined with a 29-hp electric motor – however, the car doesn’t become a resounding commercial success. In 1997, General Motors actually launches the Saturn EV1 (Electric Vehicle 1). It is regarded as the first modern-day production electric vehicle and with a range of 160 kilometers (99 miles) and a top speed of 130 km/h (80.8 mph) relatively fit for everyday driving needs. However, only 1,117 units are built and leased to selected customers for 500 dollars a month – and ultimately scrapped practically without exception.

Prius is best-in class

Only the Toyota Prius from 1997 achieves something like a breakthrough – albeit only as the first successful production hybrid rather than as an all-electric vehicle.

More than 3.5 million units have been sold to date, the fourth generation having been launched in 2016.

In contrast, it’s a newcomer from Silicon Valley that revolutionizes the battery-electric automobile market: internet multi-billionaire Elon Musk’s Tesla Motors. In 2006, the company unveils the first fully functional electric sports car named the Tesla Roadster. Its chassis has been designed by Tesla’s UK-based chassis engineering team using licensed Lotus Elise technology. The Roadster is powered by 6,831 small lithium-ion batteries of the kind used in laptops. Tesla subsequently continues this success story with the Model S, of which more 100,000 units have since been sold. Other models expand the portfolio. But Tesla has been pushing e-mobility on other levels as well, for instance with a network of charging stations and a battery factory to be established together with Panasonic.

The classic carmakers by now are taking their challenges from Silicon Valley, which include Google and Apple with their well-filled war chests, very seriously. And they should, as Tony Seba, a mobility expert at Stanford

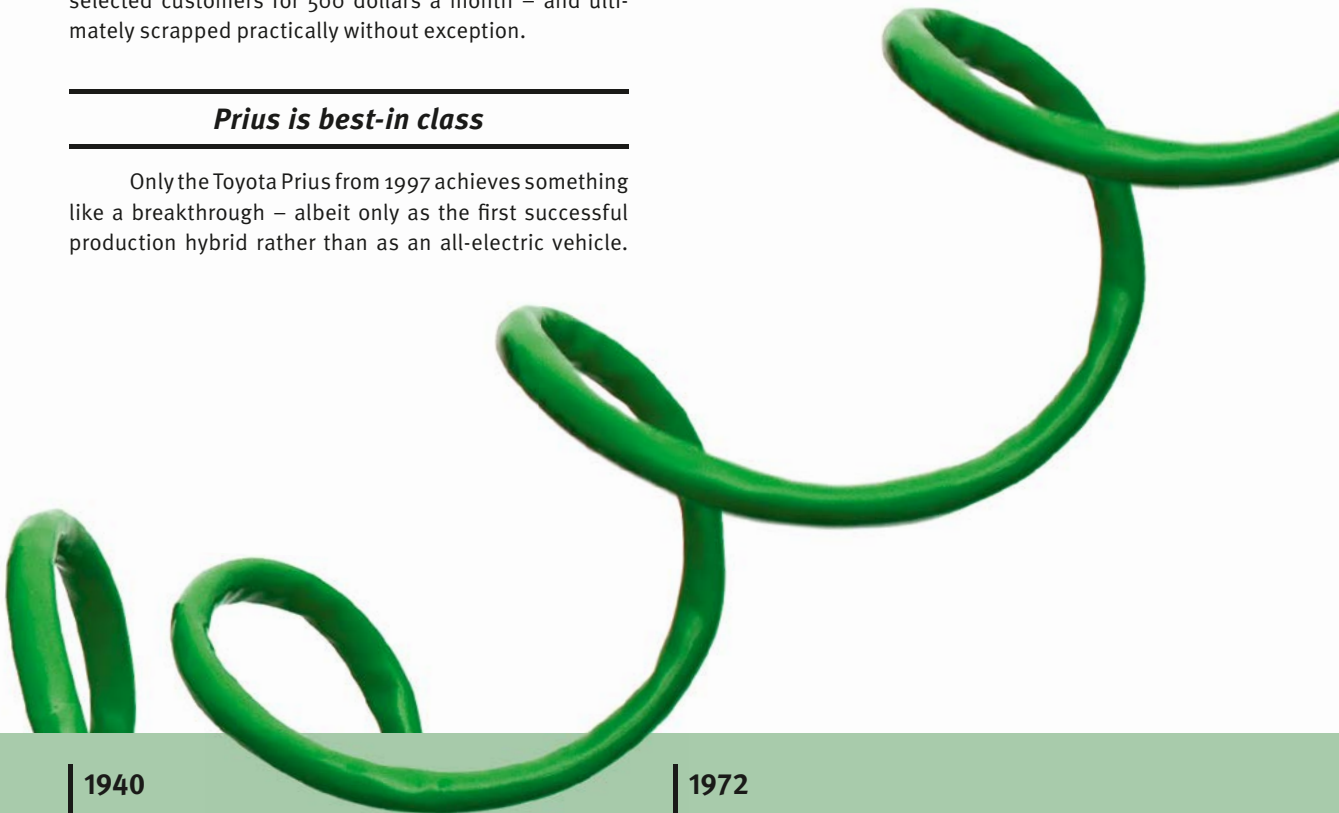

1940



30 km/h (18.7 mph) top speed, 80 km (49.7 miles) range: the plug-in Peugeot VLV was intended to outwit the rationing of gasoline under German occupation.

1972

A child born out of the oil crisis that failed to grow up: the Mercedes LE 306. The batteries as large as a coffin have to be changed after just 50 km (31 miles).



University in California, says, referring to IT companies as mavericks with nothing to lose by pushing revolutionary products into the market. Therefore, the established car-makers would have to respond very fast, or die. They'd literally have to do everything differently than in the past 100 years. This applies to both electric mobility and automated driving.

The auto industry has gotten the message. Their model ranges now extend from A as in Ampera (by Opel) to Z as in Zoe (by Renault). There's hardly a manufacturer without at least one battery electric or hybrid electric vehicle in its portfolio, some also using hydrogen as an energy source. Many governments support the purchase of such vehicles with subsidies or other incentives, though insufficient range continues to be a major issue.

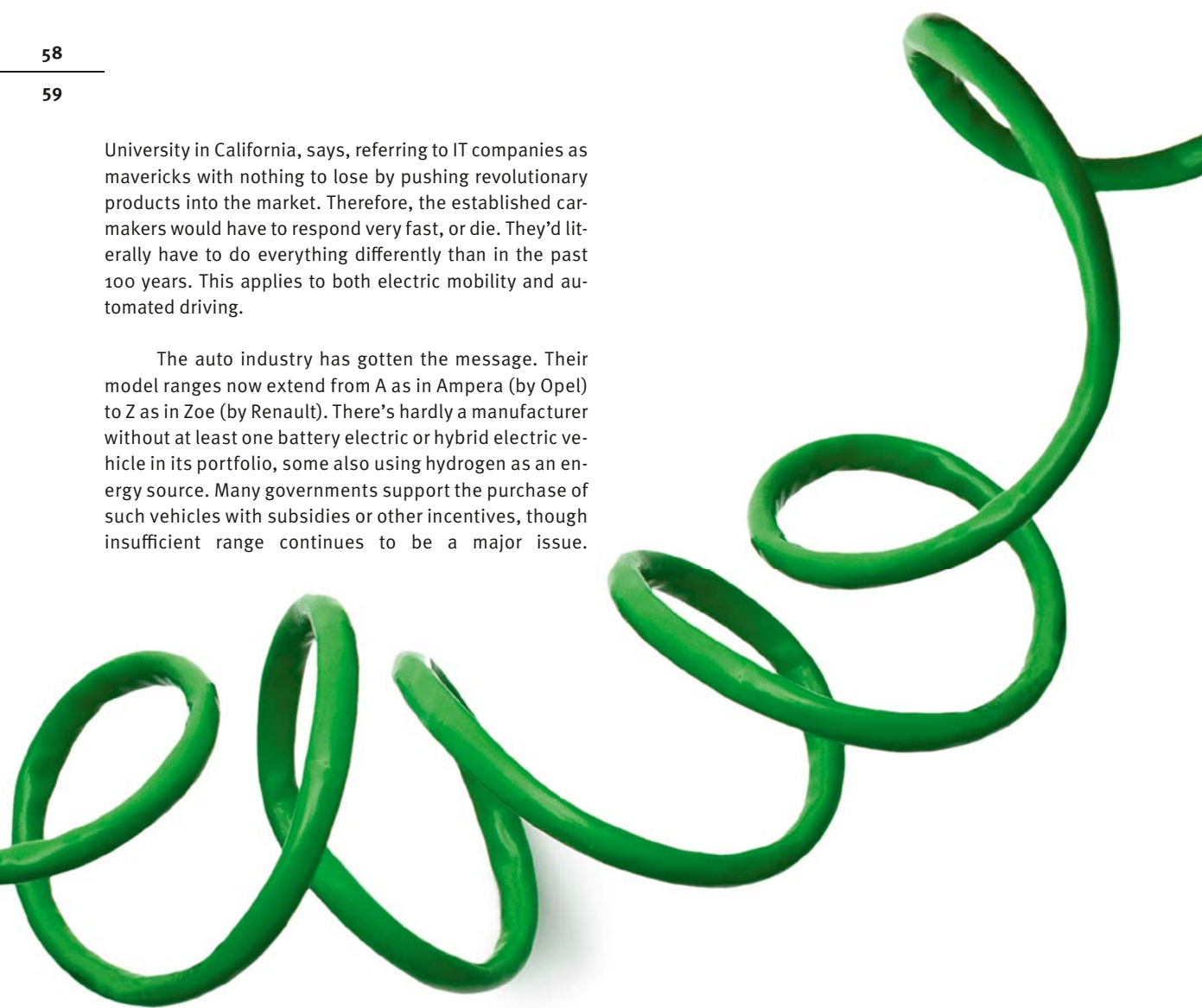

However, at the 2016 Paris Motor Show, most of the manufacturers announced future ranges of about 500 kilometers (310 miles) in affordable electric vehicles. Still, until the energy storage issue has been resolved, the prediction published in the car magazine "Der Motorwagen" as far back as in 1898 still applies: "In the coming century, electricity will be the moving force for elegant cabs and luxury cars in cities," whereas the gasoline vehicle was said to be predestined "for fast driving, long trips and extensive excursions to the countryside ..."



THE AUTHOR

Roland Löwisch, born in 1959, has been writing about old and new cars for more than 25 years – mainly those with IC engines. However, the freelancer knows all too well that it's necessary to keep up with the times, which is why he's been looking into electric mobility for a number of years, preferably in conjunction with his hobby, the history of the automobile.

1990

Opel converts the top-selling Kadett into the "Impulse" electric vehicle as a pilot project. Powered by a 20-kW high-voltage motor, it reaches 100 km/h (62 mph) and a range of 80 km (49.7 miles). That Schaeffler today achieves output of 20 kW with a 48-volt hybrid shows the progress that has been made in e-mobility in recent years.



1992

A large-scale pilot project with electric vehicles is launched on the island of Rügen. 60 electric cars participate in the test being run until 1996 – from a Fiat Panda all the way to a bus. The major issues: lack of reliability (sometimes only one vehicle is operational) and range, plus a negative life-cycle assessment due to coal-generated electricity.



SCHAEFFLER E-MOBILITY AT CES

On the road to the future, mobility is becoming increasingly integrated with electrical and digital worlds. This is another reason for Schaeffler to showcase its innovations at the Consumer Electronics Show (CES) in Las Vegas in January 2017 as well.

One of the focal topics of the company's CES lineup is drive systems for future, electrified vehicle generations – such as robot taxis that autonomously cruise through big cities. The ideal drive concept for urban use is wheel hub motors integrating all drive components up to and including the drum brake. Only the battery has to be installed elsewhere. The compact Schaeffler E-Wheel-Drive makes it possible to achieve an extremely good ratio between usable space and footprint. At the same time, it combines ideal maneuverability with advantages in terms of vehicle dynamics.

"In future conurbations, the provision of maximum mobility in minimal traffic areas will be crucial," says Prof. Peter Gutzmer, Schaeffler's Chief Technology Officer. "Innovative drive concepts, such as the wheel hub motor, enable new forms of mobility and are highly interesting components also in terms of digitalization."

Showcased by Schaeffler at CES as well are high-voltage modules for plug-in hybrid vehicles or electric axles for all-electric vehicles. But even conventional vehicles are becoming increasingly electrified. Schaeffler demonstrates the required technological solutions for them at CES too. In the field of 48-volt technologies, the company is playing a pioneering role. The compact, disc-shaped hybrid module complements the ICE powertrain which Schaeffler has been continually improving. "We expect that in ten years' time one in five cars will

be produced with such an additional 48-volt drive system," says Prof. Peter Gutzmer. With effective output in the range of 20 and more kW, the 48-volt system advances into regions that until recently used to be reserved to high-voltage drive systems.

STEP²



Concept vehicle in Golf guise. With wheel hub motors and a two-speed powershift transmission. The variable gear ratio improves fuel economy by 6%.

ACTIVE E-DRIVE

The E-DifferenTial is the centerpiece of the all-electric prototype – an innovative vehicle dynamics control system for many uses up to and including agricultural machines.



SYSTEM 48 V

An electrified rear axle plus a belt-driven starter generator in the IC engine for the front-wheel drive system. Both operate with 48 volts from a lithium-ion battery.



E-WHEEL-DRIVE

The space-saving drive system for city cars of tomorrow has already proven its viability across thousands of miles.



1997



The launch of the subsequent top-selling hybrid Toyota Prius coincides with the first modern-day production battery-electric vehicle. However, GM's EV1 is not a commercial success – in spite of 160 km (99 miles) of range and 130 km/h (80.8 mph) of top speed making it fit for everyday use.

2006



A new passenger car manufacturer emerges: Tesla, a specialist in electric vehicles challenging established brands. Its first car: a roadster incorporating Lotus technology. Powered by 292 hp, it's more than 200 km/h (124 mph) fast and goes on sale in 2008. Today, Tesla produces more than 50,000 cars per year.

FROM CHALKBOARD TO SMARTBOARD

Germany is upgrading resources – albeit at a late stage of the game. 13 years following the first PISA shock that fundamentally shook up the German educational system, one of the leading European nations is experiencing another educational low blow. The International Computer and Information Literacy Study (ICILS) has ranked Germany's 15-year-olds in the lower average in terms of digital skills, with Norway and Finland being the top scorers in the computer PISA. In Germany, 11.5 students are sharing a computer compared to 2.4 in Norway, according to the ICIL study. Federal Minister of Education Johanna Wanka (CDU) has responded and in October 2016 announced the end of chalk in schools, planning to make five billion euros available by 2021 to upgrade classroom IT. South Korea has already made greater strides in this respect. The country that's home to three smartphone producers has been implementing its digitalization strategy since 2005, but is also regarded as a warning example. The classroom world is so digitally over-saturated that the government has established 140 smartphone and internet addiction centers across the country. Even the 2016 JIM study (Juveniles, Information, Multimedia) by Medienpädagogischer Forschungsverbund Südwest (Media Education Research Association South West) in Germany proves that, among other things, the social skills and attentiveness of young people degrade due to growing digital consumption. So will solutions to complex social issues be googled in the future? Speaking of Google, employees of Apple, Google or Microsoft in Silicon Valley preferably enroll their children in Waldorf Schools. It's funny that the digital elite like to see their children sewing, knitting and harvesting. Still, the future belongs to a virtual classroom that shortens channels and teaches students how to access well-founded information. Parents and teachers have to find ways of responsibly handling smartphone and company, preferably by starting to look at their own habits.

STUDENTS ARE ALLOWED TO USE WLAN AT GERMAN SCHOOLS WITH THEIR SMARTPHONES ...

- ... also in class for classroom purposes
- ... only during breaks
- ... not at all
- Schools without WLAN

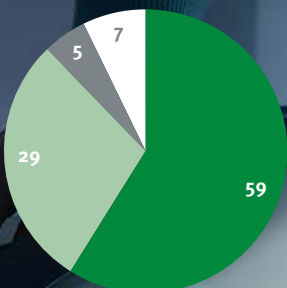

Source: JIM 2016, percentage of schools surveyed

here and now

Living with progress

» *Future skills will require students not just to have a good memory and write down what they have memorized. They will need to be able to select what is useful from various sources of information*

Cha-Mi Kwon, elementary school teacher in South Korea

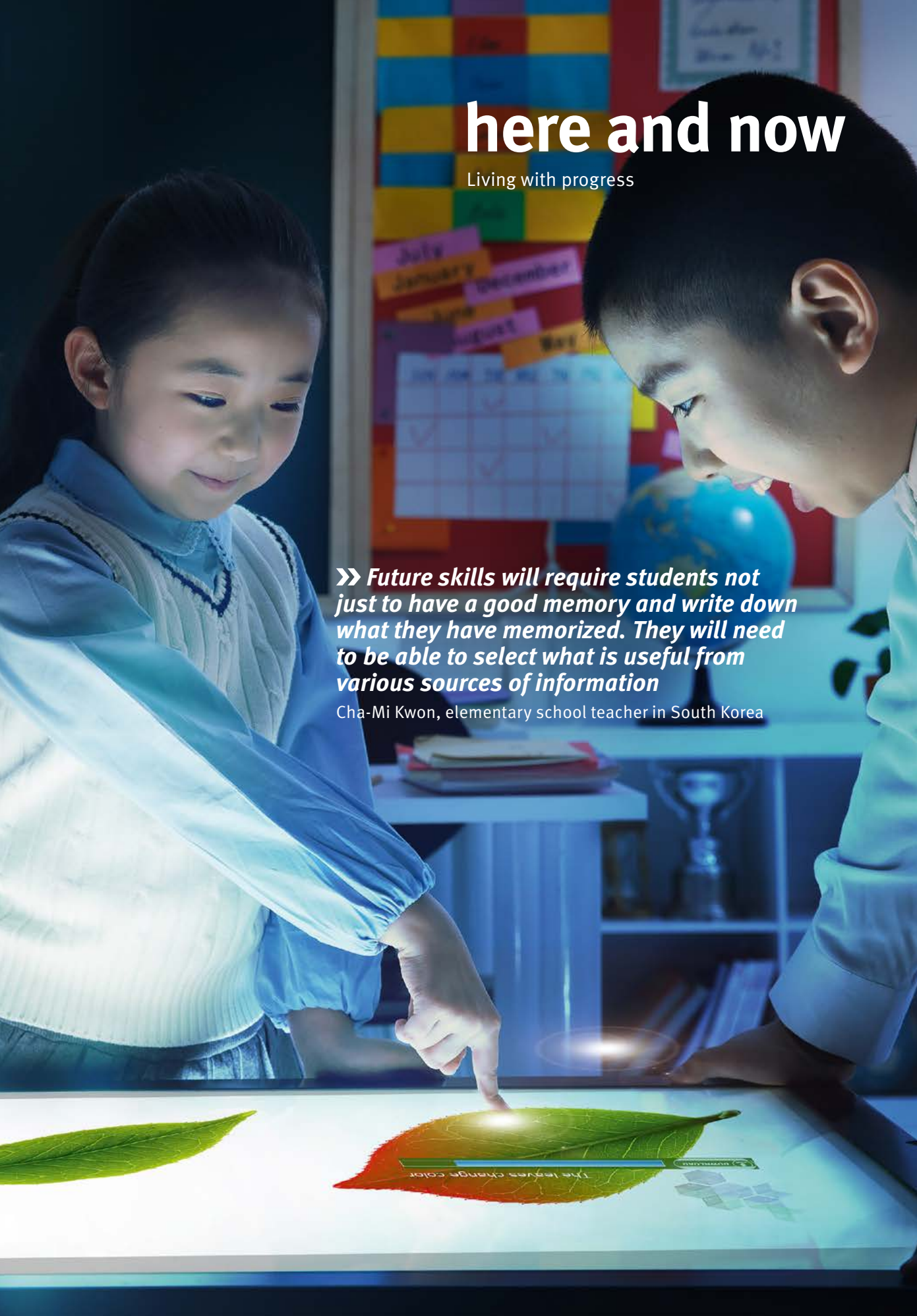



DIGITAL TURNS REAL

A new digital revolution is to bring dramatic change to mobility, energy supply and industrial production. Schaeffler has joined this revolution in many fields.

— by Johannes Winterhagen

SCHAEFFLER





— Who is Bram Stoker? These were the words with which Watson in 2011 won “Jeopardy,” a popular television game show in the United States, in which contestants have to formulate a question in response to a previously presented answer. In the course of three nights, Watson correctly answered 66 out of 75 questions, outclassing its two opponents who had previously won millions by participating in the quiz duel aired daily. Watson owes the perfection of its showing to its programmers who work on behalf of IBM. It’s not simply a supercomputer with very high computational capacity, but a so-called expert system. If Watson is fed with data, it will keep learning and can identify relevant information faster than any human being.

Since October 2016, Watson has been in Schaeffler’s employ as well. “We’ve entered into an extensive

technology partnership with IBM,” explains Gerhard Baum, Chief Digital Officer at Schaeffler. “Together, we’re going to progressively develop new industrial applications for Watson.” The digital platform based on Watson’s technology is planned to become Schaeffler’s central data hub. Although it plays a crucial part in the company’s digital strategy, it’s only one of many modules. “The development of products and services which are capable of gathering, processing and using data is equally important. In addition, we’re planning to digitize all the processes across the company,” says Baum. For this purpose, he’s currently establishing a central department in which some 25 experts will be working by the end of the year. Almost all of these employees have been recruited externally and are bringing new skills to the company that has been shaped by mechanical engineering and mechatronics: data analyses, design of user

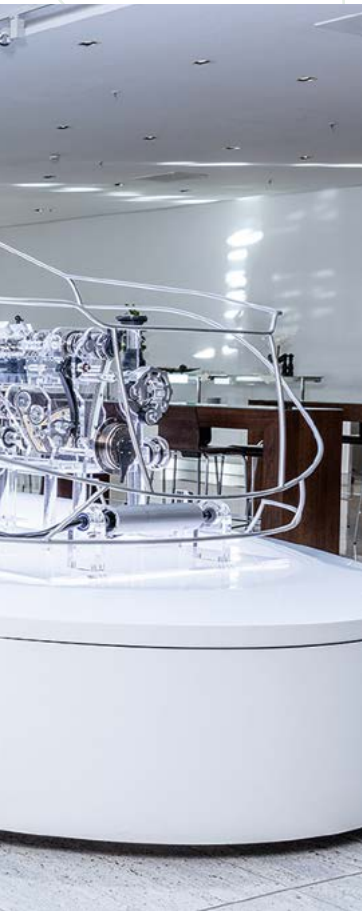

Strategic partnership signed and sealed between Schaeffler and IBM. From left: Gerhard Baum (Chief Digital Officer, Schaeffler AG), Ivo Körner (VP Enterprise Sales, IBM Germany), Prof. Peter Gutzmer (Deputy CEO and Chief Technology Officer, Schaeffler AG), Jürgen Henn (Executive Partner, IBM Global Business Services) and Harald Gießler (Chief Information Officer, Schaeffler AG)

surfaces and other capabilities that were not associated with Schaeffler in the past.

From data to findings

Initially, there's a technical reason why Schaeffler has been dealing so intensively with digitization for nearly two years now. The automotive and manufacturing industry supplier is in a key position. Rolling bearings, the company's core product, are found wherever mechanical components are in rotary motion – in other words revolving around their own axes. This refers to machines of all kinds, for instance in drive systems ranging from e-bikes to ship engines the size of a detached single-family home. The rotational speeds, temperatures or vibrations that can be measured in a bearing not only



FREEDOM

Oil pressure, temperature and torque in a machine drive – individual raw machine data, unlike engineering design information for example, does not qualify for patent or other intellectual property protection, either by the manufacturer or the operator of a system. At least, this is the current state of legislation in Europe which, however, is intensively being discussed at the moment. “This does not mean, though, that everyone can access this data, for instance in the machine tool 4.0, or data generated as part of a remote maintenance job,” explains Schaeffler’s Legal Counsel Dr. Ulrich Keil. For one, manufacturers and operators of smart machines typically enter into agreements with detailed provisions on data usage. The agreement may even stipulate the location where data is physically stored. For the other, even machine data is subject to all the rules provided for by law, for instance for the protection of business secrets or against spying out of data. In addition, processed and systematically stored data as a whole may represent a protected database, comparable to an events calendar compiled from third-party data. “Whenever we develop new, privacy-protected business models we address the legal issues early on,” says Keil. This doesn’t always concern the protection of personal data. Where machine data provides indirect information about human behavior – for instance the driver of a car – questions of “classic” privacy protection law are important as well.

ON CAMPUS

Since the middle of 2016, Schaeffler has significantly intensified its collaboration with Erlangen-Nuremberg University. Billed as “SHARE at FAU” (Schaeffler Hub for Advanced Research at Friedrich-Alexander-Universität Erlangen-Nürnberg), the company and the university are engaged in research of innovations for the digital age. The partners pursue the “Company on Campus” concept that has previously proven its viability in the collaboration with Karlsruhe Institute for Technology (“SHARE at KIT”). Schaeffler employees sit in rooms on campus, working hand in hand with professors, faculty members and students.

The range of topics to be researched as part of the collaboration was jointly defined, with three current focal areas having been derived from them: first, the digitization of value streams for the factory of the future. By



Signing of the cooperation agreement for SHARE at FAU. From left: Prof. Dr. Tim Hosenfeldt (Head of Central Innovation at Schaeffler), Prof. Dr. Joachim Hornegger (President of Friedrich-Alexander-Universität Erlangen-Nürnberg) and Prof. Peter Gutzmer (Deputy CEO and Chief Technology Officer at Schaeffler)

using sensors, data processing and data analysis, process transparency can be created and used for process and machine optimization. Second, new assistance systems based on augmented and virtual reality are elements of the research work. In the future, Schaeffler employees should no longer have to board an aircraft to learn maintenance jobs or even just a tool change on a machine. Instead, the necessary information will be communicated to them based on digital systems. Additive manufacturing

of metallic workpieces constitutes the third part of the current research projects – a step in the direction of efficient manufacturing of components with specific functional added value. FAU is a good partner for us,” says Prof. Dr. Tim Hosenfeldt, Head of Central Innovation at Schaeffler. “We’re not only creating the basis for swift knowledge transfer from research to industrial practice, but also come into contact with young talent at an early stage.”



Virtual test bench: Dr. Stephan Tremmel (left), Senior Engineer at the Department of Engineering and FAU project leader, and FAU scientist David Hochrein at the “power wall”

Machine 4.0 is digitally assisted production: data is analyzed both locally and in a Schaeffler cloud



provide exact information about the machine's operation, but also about its expected residual life. When this is known, the operator of an offshore windfarm can anticipate whether or not its wind turbine transmission is going to survive the next period of gales from September to March – and decide, as needed, whether the transmission requires maintenance before winter sets in. Predictive maintenance provides many advantages in a factory as well, such as higher productivity by linking production capacity utilization with the condition of the machine elements. In addition, spare parts can be ordered just in time to reduce warehousing costs. Self-monitoring and self-controlling production facilities are at the core of Industry 4.0, aka the Fourth Industrial Revolution, which marks the next wave of process automation.

“We’re seeing a significant digitization trend in all industrial sectors,” says Dr. Volker Maier, who will be responsible for innovation projects at Schaeffler Industrial starting in January. “With Powertrain 4.0, Rail 4.0, Wind 4.0 and Machine 4.0, plus our digital platform, we have the right answers.” In fact, the fully networked systems that have been presented at various trade shows during the course of 2016 represent a universal concept that can be adapted to diverse machines and vehicles, to wind turbines as well as to high-speed trains. “At the moment, we’re preparing our first pilot projects with international customers,” says Maier. In terms of technology, this approach is based on two core elements. On the one hand, integrated sensors and analysis systems ensure the continuous gathering of data. On the other, there is an online connection to the digital platform, a prerequisite for Big Data analyses, which makes it possible to gain valuable findings from raw data.

Big Data opens up a new playground not only to industrial customers, but also to automobile manufacturers, for instance with a new generation of the electromechanical roll stabilizer. The system corrects body roll on the road in a split second. When the data

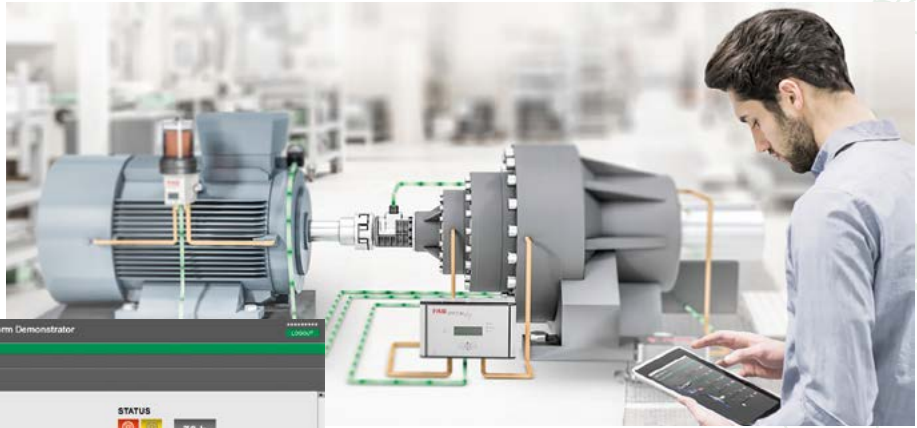

“Powertrain 4.0”: a typical engine-clutch-transmission arrangement in which the measurement module and monitoring system (left) transmit data to the Schaeffler cloud for predictive maintenance

generated in this process is combined with precise information about the vehicle’s position it may be inferred that there are bumps in the road. When the automobile as part of the Internet of Things communicates this data, it represents valuable information for other road users or for agencies that are responsible for roadwork.

From the cockpit

Not only the product but also its entire creation process is changed by digitization. As early as in the 1980s, the workplace of many engineers shifted from the drawing board to the computer. “Now, we’re facing another digital revolution,” Dr. Fabrice Mogo Nem is convinced. The expert has cross-functional responsibility for development methods and tools at Schaeffler. The most important change: In the future, field data gathered by customers is planned to be fed directly into product development. “The developers have additional access to real-world operating data rather than only to their own tests and trials,” explains Mogo Nem. “As a result, we’re able, among other things, to detect patterns, for instance about wear in specific applications, and are in a position to develop new products or services faster and at even higher levels of quality.” However, above all, the product – such as a rolling bearing – is to be developed in the future by using an integrated approach

» We’re facing another digital revolution

Dr. Fabrice Mogo Nem,
Schaeffler

together with services and even data-based business models. The search for the optimum solution is to be assisted by model-based IT tools, an ambitious endeavor, as product development largely takes place by means of highly specialized software, such as “Bearinx” or “Creo,” for calculating and designing rolling bearings. Expert programs like these will continue to exist, but are intended to provide interfaces with a central platform yet to be created.

Schaeffler will be taking initial steps in 2017. A new “Engineering Cockpit” makes it possible for project leaders, developers and product managers to keep an eye on all relevant information pertaining to a project and, as

PRUDENT FORESIGHT

If the drive system of an ocean liner on the high seas or the transmission of a turbine in an offshore wind farm (pictured) fail, it will cost a lot of time and money to replace them. To avoid unscheduled deployment of maintenance technicians, Schaeffler is developing a system that can predict the condition of such machines, which enables operators to perform predictive maintenance.

Predictive maintenance is not subject to scheduled intervals, but to maintenance requirements based on the loads that effec-

tively act on a machine. Vibration measurements provide the basis for predictive maintenance concepts. Most of the malfunctions in rotating machines lead to a change in vibration behavior. The diagnostics not only make it possible to determine the type and extent of malfunctions, but to also precisely localize them. In addition to vibrations, other parameters, such as temperature or torque, are suitable to describe a machine condition. The parameters are captured by sensors and transferred into digital models. Simpler calculations can be performed on-site, directly on the machine.

For more complex simulations, cloud-based analysis programs such as the “Schaeffler Service Cloud” are suitable. It is currently running as a pilot and able to calculate the residual life of a component in real-world conditions and to determine needs-based maintenance intervals. With an internet connection or by means of an app, operators and service teams can access this information around the globe – and thus be waiting at the next port with the right spare part to repair the calculated impending defect on the cruise ship’s drive.



Sensitive: sensors in the drivetrain report condition information of wind turbines in real time



The Schaeffler roll stabilizer as a case in point: in the future, components are going to generate and transmit data in real time

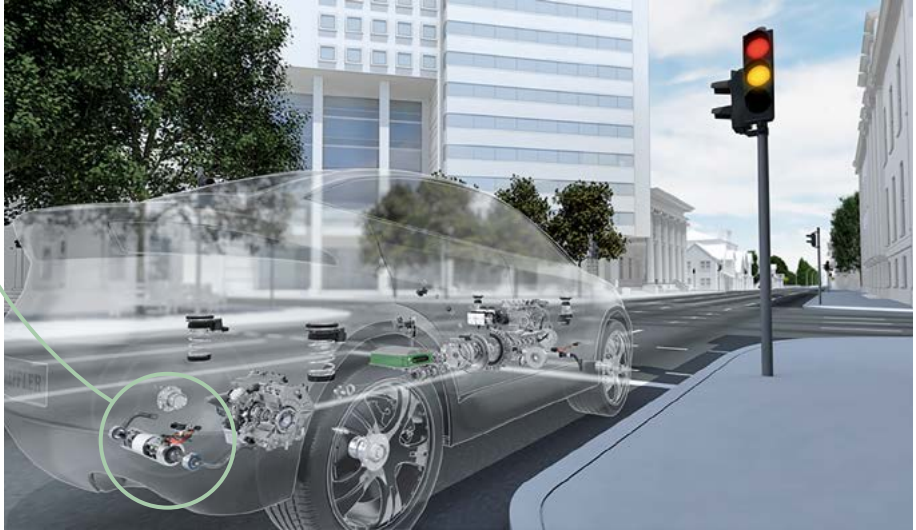

a result, to make better decisions. The Cockpit, a web-based application, allows direct access to development data distributed to a large number of development centers. In particular, it supports the company-wide Configuration and Change Management. The Cockpit for Product Development has two counterparts. Production Operations and Service Activities are planned to be controlled via similar Cockpits in the future as well. “When all three Cockpits are eventually integrated, for instance via our central digital platform, then we’ll have direct access to all details across a product’s entire lifecycle,” says Mogo Nem.

Quality mechanical work

Ten years from now, Schaeffler will be selling 20 to 30 percent of all bearings as sensors,” estimates Prof. Peter Gutzmer, Schaeffler’s Chief Technology Officer. “However, our expertise, also in the digitally networked world, is based on our ability to understand the things in the Internet of Things,” says Gutzmer. “Our mechanical expertise, paired with mechatronics and, increasingly,

software, is the basis of our business model.” This becomes particularly important in a world that relies more and more on autonomous systems. Self-driving cars or robots that work hand in hand with people on the factory floor have to function reliably and safely – in the real world in which there is no time for a system reboot. —



THE AUTHOR

Johannes Winterhagen, a technology journalist and founder of the delta eta editorial office, used to program an Atari as far back as in his school years in the early 1980s. In spite of his enthusiasm for digitization, he still prefers reading books and magazines in perfectly analogue style on paper.

“WE CONTRIBUTE OUR **EXPERTISE IN THINGS**”



Prof. Peter Gutzmer (Deputy CEO and Chief Technology Officer of Schaeffler AG)

Digitization and a networked world in harmony with the mechanical world – an interview with Prof. Peter Gutzmer about exciting topics in a fast state of flux.

— Professor Gutzmer, digitization is on everyone’s lips – a classic buzzword?

I’m convinced that digitization is going to change the world in major ways. It not only changes our products, but also all the processes in companies and, not least, our working world as a whole. This transformation is going to happen at a rapid pace. Just think about how quickly we got used to smartphones and how they’ve completely changed the way we communicate.

Schaeffler has its roots in precision mechanical engineering and is increasingly developing mechatronic systems. Will these competencies soon be old-school?

No, they definitely won’t. Quite the opposite is true. We contribute our expertise in things to the Internet of Things. Data may be the new gold but, initially, it’s nothing but zeroes and ones. You can only remedy something when you understand what might be behind an observed

pattern in the physical world. We’re expanding our expertise in the field of digitization by hiring new people and through partnerships with IT companies, but this doesn’t mean that we’re giving up our core competencies.

Talking about partnership: what does the cooperation agreement with IBM mean for Schaeffler as a company?

In a networked world, you need to network with the right partners. It would be totally presumptuous on our part to try to catch up on the advance in knowledge that IBM has built in the field of data analysis for decades within a short period of time. Instead – drawing on our knowledge of the real world – we can ask the right questions which expert systems like Watson can then answer. For us at Schaeffler, IBM is not only a good partner in this respect because our competencies

complement each other so well, but because IBM is a globally active company – like we are.

How is our mobility going to change as a result of digitization? Are we still going to buy attractive cars or only transportation services?

Like in other cases, I feel that “as well as” is the only right answer here. There’ll still be a demand for mechanically perfect, attractively designed automobiles in the future. And people are going to buy them too, and not just rent them on an hourly basis. However, a new mobility world will emerge in parallel, in which all kinds of services can be ordered by smartphone. Eventually, this will include self-driving robot taxis. But don’t think that the mechanical system won’t be playing any part in such vehicles anymore. Who would entrust their life to a machine that doesn’t function perfectly under all circumstances?

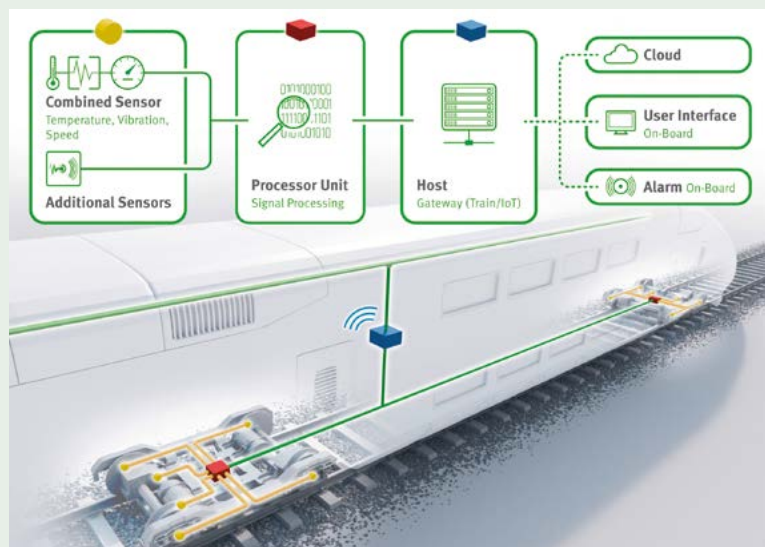

Digitized mechanical systems: monitoring systems with local software and cloud-based analytics increase operational liability and reduce costs



A VEHICLE TO CARRY ALONG

What gadgets can we use in the future to conveniently cover short distances? And how does that feel? Schaeffler intern Michelle Biegel tested an electric skateboard for “tomorrow.”

— by Michelle Biegel



— “How are we going to travel in 20, 30 or 40 years from now? Probably not as often as today in a privately owned car. I can imagine that we’re going to use clean and fast buses and trains. But who likes to walk home from a bus stop? Or from the subway station to the office? No doubt, there’ll be modern technical assistants for this. Companies, today, are already experimenting with solutions for the inconvenient last meters, often referred to by experts as the ‘the last mile.’ At the moment, only few people make traveling short distances easier for themselves by using bicycles or pedelecs. Even muscle-powered scooters or kickboards we remember as loyal everyday heroes from our childhood days are rarely seen in the city. So, for my ‘tomorrow’ field test, I went looking for a cool and practical electrical means of transportation for the ‘last mile.’

An assistant must be light and practical

The arguably best-known ones such as a bicycle with an electric motor, called a pedelec, or a Segway for instance are no options for me: too big and too heavy. A monowheel, which is practically a compact Segway, was not an appropriate choice either due to its looks and acrobatic demands. You don’t want to look totally ridiculous on your way to work, do you?

Factors like battery range and weight of the device – after all, it has to be carried up to the fourth floor, into the train and to the office – played a crucial part in the selection as well. So, electric skateboards are a smart solution: four wheels, compact size and acceptable weight. Therefore, for the ‘tomorrow’ field test, I opted for the E-GO2 model from Yuneec in the UK. It offers a 400-watt motor plus continuously variable remote-controlled speed using two riding modes and adjustable axles.”



All-new possibilities:
Michelle rolls all the way
to her desk on an e-board



! *The market for e-bikes is booming. Between 2009 and 2015, sales in Germany went up by 350 percent. Smaller electric vehicles are still having difficulties in the marketplace, not least because the law prohibits their use in many places, as in Michelle's case. E-boards are not allowed in Germany. Legally, they're classified as motor vehicles, but may not be used on roads because they're neither insured nor have a license plate or lights. Their use on sidewalks is taboo as well because they reach speeds above 6 km/h. That's why for the photo shoot Michelle was strictly riding the board on private property and in blocked off areas. But a technology the use of which is currently a punishable offense may turn into a technology of the future because, as the desire for mobility grows, so does the pressure on legislators. An initial step was taken with the Segways. For years, their use required a special permit, but now they're classified as motorized cycles and may be used with a license plate and insurance coverage.*

E-board even masters cobblestones

"I have great reservations about tackling the e-board challenge, being particularly awed by steering the board as an absolute rookie. And how am I going to cope with different types of road surfaces? Will I be able to reasonably steer and brake? My concerns are dispelled right during my first ride. After just a few trials, I'm able to ride the board. It's agile, accelerates and brakes fast. However, you shouldn't do this too fast either because falls on hard asphalt are not pleasant. My first impression: on the board, I'd move faster even through the crowded center of Frankfurt than on foot. When you arrive at the train station or can't continue riding on stairs or at other obstacles you just tuck the light 6.3-kilogram board under your arm, which is difficult to do with heavy devices like the Segway, a pedelec or even a monowheel. On a wet ground in rain, acceleration is a little more difficult and you should be careful when braking as well. I particularly like the fact that, thanks to the large, 90-millimeter wheels, you can easily ride over smaller curbs and cobblestones without having to get on and off the board all the time."

An eye-catcher that may send you flying: the electric board used in the "tomorrow" test poses a challenge to beginners because it has no handle





! *Talking about accessibility: not only people in wheelchairs and mothers with baby buggies benefit from leveled sidewalks and wheelchair ramps, but so would anyone wishing to use a modern board like this in the city.*

“I’m not totally happy with the e-board. The thing that’s particularly annoying is having only one hand free. While riding, you’re holding the remote control in your hand and while shopping or boarding a train, you tuck the board under your arm because you can’t just leave and lock it like a bicycle. But the battery lasts for 30 kilometers, so you rarely need to stop for charging. Quite to the contrary, my E-GO2 also serves as a charging station in the event that my smartphone battery goes dead while I’m out riding the board.”

! *First, there’s a demand for a technology and then its fine-tuning follows. Anyone who bought a cell phone in the 90s had to lug a device the size of a briefcase around. The situation with e-boards may be similar. Once gadgets like these are permitted and spreading, lighter and smaller*

models might follow, as well as useful accessories such as mini locks, carrying straps and controls using smartphone apps as well as a corresponding infrastructure with parking places and charging stations.

“I find it particularly amusing that I’m constantly approached by interested people of all ages. Because you can rarely see such an e-skateboard in Germany people want to know more about it and you get into conversations with them. So that’s another advantage that makes train rides more pleasant as long as these devices aren’t widely used yet. My conclusion about the e-skateboard is positive. I figured out that the time I need to walk to work is cut in half. It’s a sensible alternative below the level of bicycles or scooters. Plus, there’s another thing I shouldn’t forget to mention: it’s huge fun.”



THE AUTHOR

Michelle Biegel, an intern in Schaeffler’s Aftermarket division, privately uses a pedelec. New mobility impressions are awaiting the 18-year-old in 2017 when she goes to Australia for work and travel.

THE LAST MILE IN MOBILITY

Companies that come up with efficient solutions for the last segment from the final stop of a train or bus to the traveler's destination or from the parcel delivery center to the customer will secure a share in a market worth billions.

The term “last mile” was coined by the information and telecommunications technology sector. It describes the last segment of the internet line from the junction box to the user's house, which often still consists of an old copper line and, as a result, slows down communication at gigabyte-speed on fiberoptic cables. The mobility world faces similar issues. While buses, trains or planes today largely guarantee reliable and fast connections in the city and in rural regions, the last mile from the last stop to the traveler's final destination is a bottleneck in this case as well. Walking only works well with little luggage, plenty of time, an umbrella or at least halfway decent weather. And those who don't mind paying for a taxi will at least have to contend with an additional waiting period or meticulously plan their trip by ordering a taxi in advance and then hope to arrive on time.

The alternative to public transportation, a privately owned vehicle, doesn't provide any advantages in urban areas today: acute lack of parking places, driving bans and

traffic jams slow down personal mobility and often just shift the “last-mile” problem from the final bus or train stop to the respective parking place. Car sharing services like car2go or DriveNow and bike rental stations at bus stops or train stations are approaches to a solution, but not optimally suited for every need. That's why nearly every company that's active in the mobility sector is currently working on elegant solutions. In development, for instance, are futuristic vehicles that require little parking space and can be rented like bicycles at bus stops or train stations. Others are favoring so-called “Personal Light Electric Vehicles” (PLEV).

PLEVs are small vehicles like electric kickboards, e-longboards or rolling mini platforms such as CarrE by Ford. It can either carry people or luggage and be taken along in a car without taking up a lot of space. To the logistics sector, the last mile poses an even greater challenge. A company that pioneers a solution which simplifies the time-consuming and costly deliveries by trucks or vans and minimizes wrong deliveries will have access to a market worth billions. As a result, the competition in this sector is in full swing, with drones, autonomous mini robots and cargo bikes with electric motors battling for market share. In the future, however, according to estimates

by experts like Christian Scherf, a technology sociologist at the Innovation Center for Mobility and Social Change in Berlin, the concept of the last mile could gradually disappear, as absolutely safe and organized automated driving – be it vans or passenger vehicles – could be playing a major part in this scenario. Logistics and local transit would then be possible in more efficient and safer ways than ever.

— by Denis Dilba



E-BOARD FROM SCHAEFFLER At CES in Las Vegas in January 2017, Schaeffler is showcasing an electric kickboard. With two axles and a comfortably sized board area, it resembles a skateboard. Integrated in the board area is a battery that provides propulsion via an electric motor at the rear axle. The kickboard is steered via a stick with an ergonomically shaped handle. As a solution for the last mile, it's intended to make it easier for people to use public transportation and car sharing services in urban areas.

... IN THE PIPELINE

AUTO ON DEMAND The Danish Spiri project is reinventing the taxi. The light vehicles weighing 750 kilograms feature an innovative design and are energy-efficient, comfortable, self-driving and low-cost. The future vision: just hail a Spiri by means of an app and have it take you to the office. The pilot project will kick off in 2017.

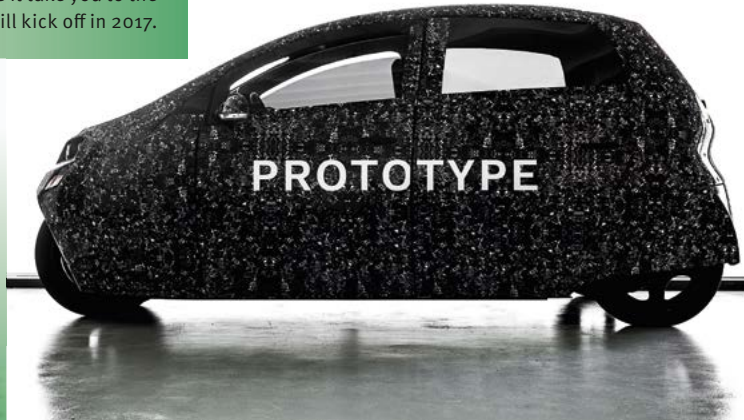

MOVING SIDEWALK The Motowalk from Imaginactive can move larger crowds in business districts and city centers, and is more flexible and efficient than bus shuttles or trains. Similar moving walkways are already being used at airports.



ELECTRONIC BUTLER The self-driving robots from Starship are intended to revolutionize local deliveries. Within a radius of five kilometers the rolling assistant picks up purchases at stores and delivers them to the owner's doorstep. Or it can be taken along for shopping to carry the bags.



HIGH-FLYER Since 2015, the Swiss Postal Service has been running tests with drones. A maximum load of five kilograms can be transported at a speed of 60 km/h across a 20-kilometer distance. In 2017, DHL will be launching a commercial drone project in Switzerland.





THE FUTURE WILL BE ELECTRONIC

Although the torque converter isn't quite as old as the IC engine, automobiles with automatic transmissions have hardly been conceivable without it for the past three quarters of a century. In the age of electronic integration and hybridization, this module is now facing its greatest transformation.

— by Alexander von Wegner



— When Hermann Föttinger developed the concept of a torque converter and hydrodynamic clutch in 1905, the foundation was laid for a new type of hydraulic assembly. In 1928, the converter found its way into locomotives. When the American automaker General Motors introduced its Hydra-Matic transmission in mass production of the Oldsmobile brand, the breakthrough was achieved on the road as well. The new transmission soon set standards in terms of safety, comfort and performance. Nobody had to operate a manual clutch anymore or concentrate on shifting, as the smooth flow of the vehicle's motion and damping of vibrations made for a more comfortable ride and, ultimately, the converter would transfer the output of even the most powerful engines – without being prone to wear, unlike the conventionally used friction clutch.

In 1990, Schaeffler's LuK brand in Bühl/Germany started developing converters. Since its invention, the converter's basic principle of transferring power, using a pump impeller, turbine wheel and guide wheel in an oil bath, has not changed. Breakthrough changes have only occurred recently, not only being linked to the aspect

of power transfer, but the automobile as a whole. Up to now, the converter has been a favorable complement to the engine in that it enables smooth starting from rest and separates the drivetrain from the vibrations emanating from the engine.

Innovative solutions by Schaeffler

However, current environmental legislation is stipulating lower and lower CO₂ emission limits while torque keeps increasing. This has prompted manufacturers to develop downsized engines with less cubic capacity and fewer cylinders. Turbocharging, however, ensures high power output and torque. This, though, makes greater demands on the converter in terms of isolating the transmission from rotational irregularities. The excitations of turbocharged, small-volume engines are clearly higher than those of previous units. These rotational vibrations are typically absorbed by spring dampers which compensate for the irregularities caused by the individual combustion events. The size of the spring is crucial for this effect.

1 Optimized solution in minimal assembly space: torque converter with centrifugal pendulum absorber

2 United: The modern P2 high-voltage hybrid module from Schaeffler combines an electric motor and an automated disconnect clutch that is integrated in the rotor. A torque converter is possible as well

3 Fewer components, more effective absorption: the iTC converter from Schaeffler

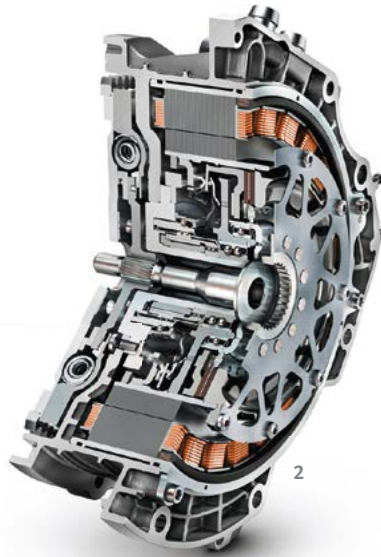
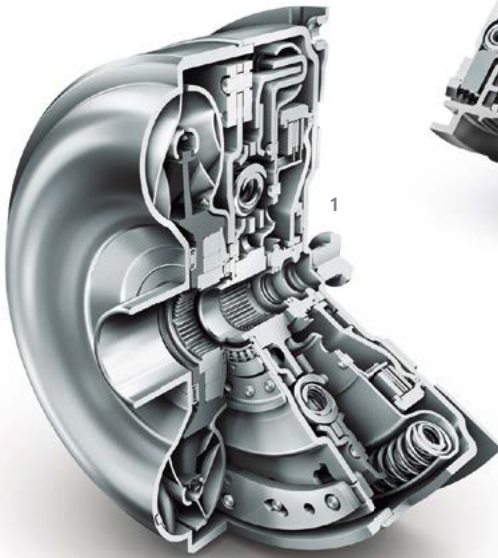

THE ONE MILLION MARK

Since 1990, Schaeffler has been developing torque converters as well. Its subsidiary LuK in Bühl began the converter development back then. Whereas the American site in Wooster/Ohio is the competence center in Schaeffler's global development network, production was also launched in China, in April 2014. In 2016, the millionth torque converter left the line at the Taicang plant. No other converter project in the world has seen such a rapid development in such a short space of time.



Space, however, is at a premium. As assembly space is particularly scarce in the case of transverse engines, Schaeffler offers a centrifugal pendulum absorber as an optimized solution. It debuted in the dual-mass flywheel and has since been integrated in the torque converter. To enable this integration, Schaeffler created the Integrated Torque Converter (ITC) consisting of fewer components than a conventional converter, which allows for space to accommodate the centrifugal pendulum absorber.

Another step on the road toward the digital age is the mTC converter. This multi-functional converter is ideally suited for combination with start-stop systems that make modern engines even more fuel-efficient. In addition, the mTC converter can compensate for delayed responsiveness – known as turbo lag. Furthermore, the multifunctional converter can be decoupled when the engine idles and is able to bridge the converter function at an early stage. Thus, this innovative assembly from Schaeffler contributes to enhancing fuel economy by up to five percent.



Focused on mobility for tomorrow: Schaeffler is engaged in various drive concept developments in many areas

The, arguably, largest step – hybridization – is now on the agenda. The new P2 high-voltage hybrid module consists of an automated disconnect clutch and an electric motor. It covers a torque range of up to 800 Nm and can be used in both 48-volt architectures and powerful high-voltage drive concepts. Production of this development will be launched in the near future. For the American market, Schaeffler is developing a variant with an integrated torque converter from the P2 hybrid module. This high-voltage solution in a very compact

assembly space will debut in a North American light truck within the foreseeable future. “We develop these solutions together with our colleagues from the fields of engine/motor systems and e-mobility, looking at the IC engine, the electrical components and the transmission as a whole,” says Matthias Zink, Head of Transmission Systems at Schaeffler. This interaction of know-how from various disciplines is one of Schaeffler’s great strengths. “With that, we offer automobile developers optimum total system solutions.”

REGIONAL SHIFTING HABITS VARY

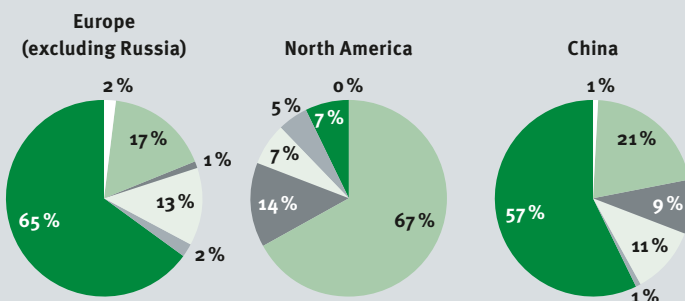

Source: IHS Automotive

Forecast of the distribution of the various transmission systems and gearshifts for 2018

- Automated manual transmission
- Classic torque converter automatic transmission
- Continuously variable transmission
- Dual clutch transmission
- Electric vehicles
- Conventional manually shifted transmission



ON THE MOVE

Schaeffler has been driving rail technologies forward with its innovations for many years. Digitized monitoring and maintenance is one of the focal topics in designing rail-based mobility of tomorrow.

— *by Torben Schröder*

— People and hardware were transported by train long before the invention of the automobile and the airplane. Consequently, trains are one of the oldest means of transportation and are playing a major role in current and future traffic scenarios.

In a megacity like Hong Kong the subway is by far the fastest, cheapest and most efficient means of transportation. The local operator, Mass Transit Railway, hauls 4.5 million passengers per day. In the field of interurban mobility, efforts to upgrade the systems are underway around the globe as well. A case in point: The “Shinkansen” magnetic levitation train network in Japan is currently being expanded by a more modern line from Tokyo to Osaka, its completion being expected by 2045. The total costs for the mammoth “Chūō-Shinkansen” project amount to more than about 70 billion euros. In the freight sector, rail transportation is still ranked in second place behind truck haulage. However, several studies prove that the environmental impact of transporting goods

by rail is clearly lower than by truck. In times of climate change, this is an opportunity to shift the conditions.

A century of expertise

For Schaeffler, the rail sector is like a home match. The technology corporation has been developing solutions for bearing applications in close collaboration with manufacturers and operators for 100 years. A component subjected to extreme loads on a train is the wheelset bearing which represents the interface between the wheelset and the bogie or “truck” that is connected to the railcar. Wheelset bearings from Schaeffler – from subway to high-speed trains – are used around the globe and require special care. “Today, maintenance is performed according to scheduled service intervals,” explains Dr. Hans-Willi Keßler, Head of Service Products Technology at Schaeffler. “This involves dismantling, cleaning, restoring, lubricating and reassembling work.”

Initial prototypes of digitized monitoring and maintenance from Schaeffler were successfully tested in high-speed trains as early as in 2015

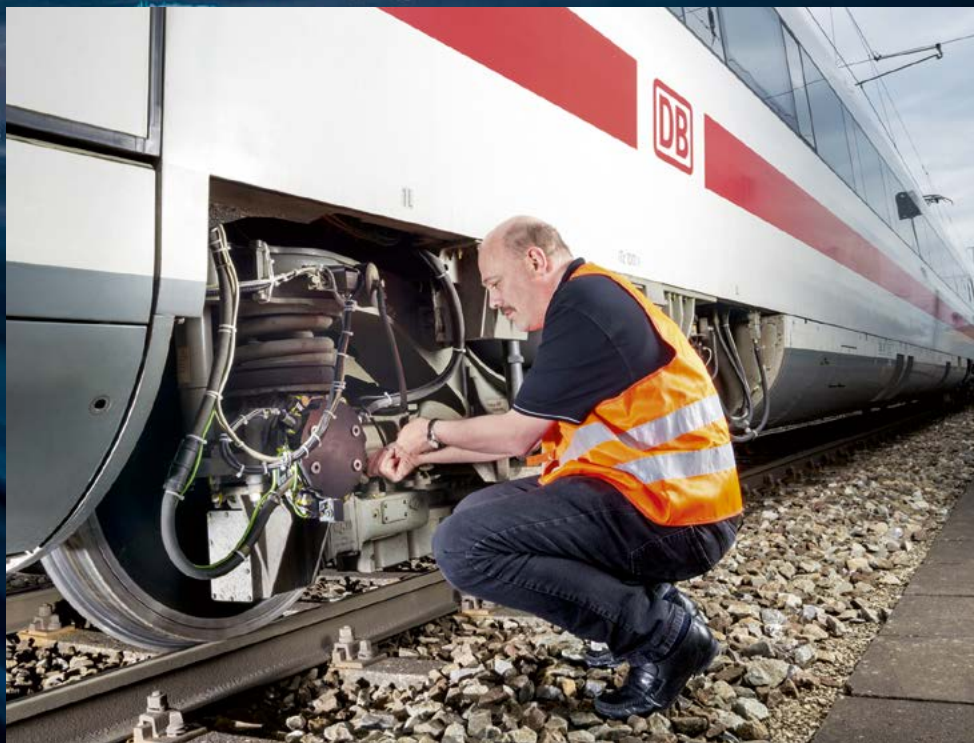



Combi sensors (above) capture temperature, vibration and speed for the new Schaeffler CMS. The results are indicated in the Schaeffler cloud or on local devices in human-readable form (right)



10 B

passengers per year use short-range transportation services in Germany, which corresponds to nearly 27.4 million passengers per day. Thus, with an average of 1.4 persons per car ride, buses and trains replace 20 million car rides every day.

Source: Verband Deutscher Verkehrsunternehmen

200 watts

are produced by Schaeffler's **wheelset generator** at a speed of 150 km/h (93 mph). Further developments to generate outputs of up to 1,000 watts are basically possible.

However, these jobs do not take into account the actual loads the components have been subjected to. For a German ICE train, the removal of the entire wheelset bearing is scheduled after 1.2 million kilometers, equating to nearly 2,000 trips from Hamburg to Munich. As an ICE train travels 1,500 kilometers per day on average, maintenance is due after a little less than two years. This is generally not necessary, though, because under normal operating conditions, the mechanical components are not prone to wear. Consequently, the wheelsets could be used longer than the labor- and cost-intensive maintenance intervals permit.

Optimizing processes thanks to digitization

At InnoTrans 2016, the trade fair for rail technology in Berlin, Schaeffler demonstrated how these scheduled maintenance events "on suspicion of defects" can be counteracted by means of digitization. A Condition Monitoring System (CMS) permanently monitors the condition of the components using intelligent software and a cloud connection. Consequently, any maintenance and repair work is initiated only if actually required. The objective of the CMS is to enable higher average speeds,

SILK ROAD RENAISSANCE

In a project billed as "One belt, one road," China has been driving the development of an intercontinental infrastructure connection to Europe forward since 2013 – taking its cue from the age-old trade route between the two continents, it's also referred to as the "new Silk Road." In view of the nearly 60 countries involved, six economic corridors and four free-trade zones, there is an enormous need for railway business solutions which Schaeffler helps make reality.

longer mileage and longer maintenance intervals for future generations of trains. At the same time, operating reliability is improved.

This is how CMS works in detail: Sensor units specifically developed for rail applications make it possible to measure solid-borne noise, temperature and rotational speeds on the wheelset bearings, thus enabling defects – such as rolling bearing failure and imbalances on the wheel tires – to be detected. On the motor bogie, the drive motor and transmission can additionally be monitored by vibration measurements. A processor unit processes the raw data into characteristics, which reduces the data volume to be transmitted. Subsequently, the automated analysis of this data is performed either in the Schaeffler cloud or on a local device. The result is issued in the form of human-readable text, in other words, the engineers don't have to interpret complicated hieroglyphs, but can simply read what measures must be taken.

The lubricant is another crucial aspect with respect to the durability of a wheelset bearing. Due to shearing forces, pressures and high temperatures that occur in operation, the lubricant ages both mechanically and chemically, and gradually loses its effect. In the worst case, this can lead to a so-called wheelset hot box – which means the train would have to be taken out of service immediately. How fast this aging process takes place is heavily dependent on the service conditions, which the Schaeffler CMS addresses as well. "Schaeffler's grease service life calculator calculates using real loads. This makes it possible for maintenance teams to run load-dependent cycles, which saves costs," says Dr. Hans-Willi Keßler.

The most prominent guest at the well-frequented Schaeffler booth at InnoTrans 2016 was Federal Transportation Minister Alexander Dobrindt. He called Schaeffler a good example that showed how German companies manage to accept the challenge of digitization and transform it into viable forward-thinking mobility solutions.

MECHANICALLY INNOVATIVE

Today, a locomotive and the railcars it pulls are predominately made up of mechanical components. Schaeffler is committed to improving these components as well. Some of the results achieved were presented at InnoTrans 2016. The new Mancrodur material for rolling bearings in combination with carbonitriding – a case-hardening process with carbon and nitrogen – is now also used as a tapered rolling bearing unit in heavy freight applications. "Even when subjected to extreme loads and shocks, the Mancrodur bearing delivers performance exceeding that of standard steel by 30 percent," says Matthias Kilian, Senior Manager Product Management Sales at Schaeffler.

Another Schaeffler invention is the wheelset generator as a self-sufficient way of supplying freight rolling stock with electricity, enabling the use of additional functions such as GPS, condition monitoring, lighting, braking assistants or operation of the hinged doors on hopper cars.

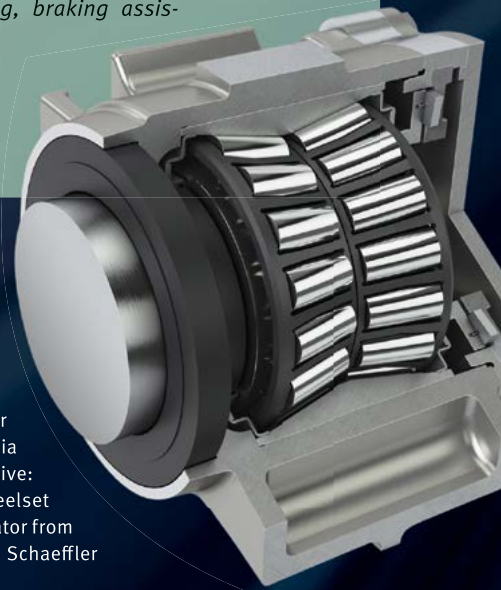

An alternative to power supply via the locomotive: the wheelset generator from Schaeffler



Dr. Stefan Spindler, CEO Industrial at Schaeffler (right), in conversation with Federal Transportation Minister Alexander Dobrindt at InnoTrans 2016

THE TRANSPARENT DRIVER

Without extensive data analysis, motorsport is no longer conceivable today. But the teams are faced with diverse challenges, depending on the racing series.

— by Lars Krone



» Sometimes you spend several hours pondering the data with the engineer

Mike Rockenfeller



— “No, I didn’t over-rev the engine.” Up until the 1980s, this used to be a popular excuse by race drivers following an engine blowout, suggesting the blame should be put on the material. The teams had no means of actually checking the truth of this statement back then, as race drivers would often tamper with the tell-tale needle of the rev counter to keep from being blamed for catastrophic engine failure. But then the age of data analysis in race cars began – and that of the transparent driver. Since then, sensors in the car, in the engine and in the tires have been measuring thousands of parameters – roughly comparable to an ECG in medical practice. These parameters are stored, transmitted and analyzed by the team. Everything a driver does in the vehicle can be checked today.

Whether or not the driver was the cause of engine failure has long ceased to be the issue. “We analyze data for two reasons,” explains Florian Modlinger, Project Leader Test & Technology DTM at Audi Sport. “One is to optimize the setup in order to extract maximum performance from the car and the other one is to increase the driver’s performance. You can only do this by comparing a driver’s data with that of another driver to see in what areas time is being lost. Simply put, the aim is to be increasingly faster on the race track.”

Aside from performance-relevant data, there are other areas being checked by sensors. For instance, monitoring the most important vehicle systems can significantly reduce the probability of failure. But safety is enhanced as well. The team, for example, often detects imminent tire failure earlier than the driver

In the WEC, data is transmitted in real time via antennas using diverse frequencies and standards. The L-shaped pitot tube is used to measure speed



A LAP WITH THE FORMULA E CAR IN PUNTA DEL ESTE

The top green curve shows the gear being used. The Formula E race car, which only has a three-speed transmission, uses only first and second on the circuit in Uruguay.

The blue curve shows the steering angle. The higher the peaks, the more the driver steers to the right, the lower the valley, the larger the steering angle toward the left. Notably, the driver usually has to slightly steer even on the straights to compensate for offset caused by track irregularities.

The most important curve: It shows vehicle speed. The higher the peaks the faster the car is running.

This curve shows the output of the electric motor. When the curve peaks, the motor is operating at its maximum output of 200 kW, while valleys indicate that energy is being recuperated.

This is where brake pressure is depicted. When the car is running faster the driver can brake harder due to more downforce being generated

and the wheels won't lock as fast. When the driver brakes on entering a turn brake force decreases.

The green curve shows the position of the accelerator pedal. For the most part, the driver runs flat-out. When the curve bottoms out the driver is coasting to save energy.

This is where the distribution of the brake force to the two brake circuits is shown. Depending on the direction the curve points to, either the front or the rear one is under heavier load.

An initial data analysis is performed while the Formula E session is still in progress

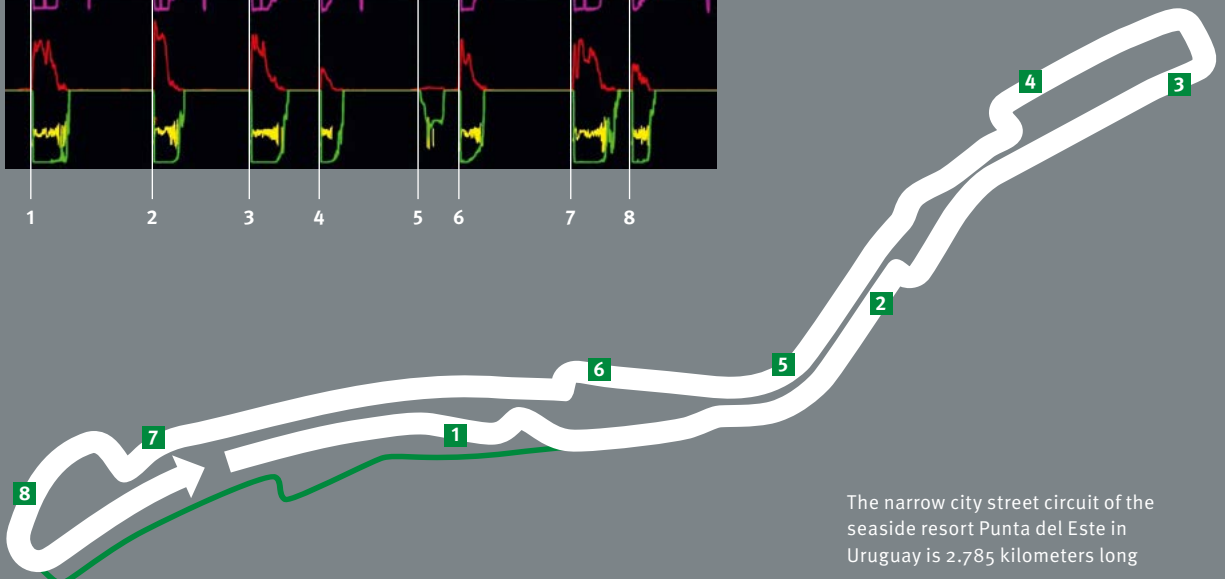
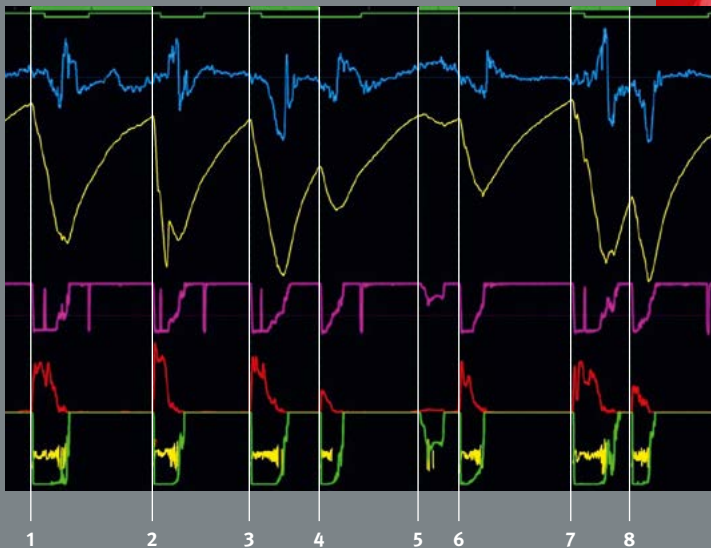

The narrow city street circuit of the seaside resort Punta del Este in Uruguay is 2.785 kilometers long



60 GB

of data was gathered by Team ABT Schaeffler Audi Sport in the 2015/16 Formula E season.



Dr. Simon Opel (L.) and Schaeffler's Chief Technology Officer Prof. Peter Gutzmer

DATA EXCHANGE

Schaeffler benefits from data gathered in racing as well. “However, we don’t analyze this data as much in direct testing or racing operations but rather subsequently,” says Dr. Simon Opel, Head of Special Projects Motorsport at Schaeffler. “Especially with respect to electric mobility, this data is very important for us. That’s why Formula E is ideal because this is where we can test new coatings or bearings. If they prove their viability, then we can use them in production cars as well.” In addition, the data serves to test simulations for accuracy by comparing the results with reality. Simon Opel: “This is important in regard to efficiency, as even small inaccuracies can have major effects there.”

and can call him into the pits for a tire change in time. Not only the team relies on telemetry, though, but so does race control. The vehicle’s speed is tracked by GPS measurements to check if a driver is too fast during a caution period.

First analog, now digital

The early days of data logging in racing date to the 1960s. The American Jim Hall in his innovative Chaparral sports cars for the legendary Can-Am series and the World Sportscar Championship was one of the pioneers. By means of a device developed by Chevrolet, data such as vehicle speed and engine speed was stored – typically just of one lap due to lack of storage space. This was done in analog form on tapes as suitable digital storage devices didn’t exist yet in those days.

Data logging became an integral component of racing only in the 80s, thanks to the major progress achieved in computer technology and was pioneered primarily by Formula One. Now it was possible to store data on floppy disks for subsequent reading in the pits. In 1983, Renault was the first to transmit data from the

track to the pits by telemetry in real time. Every time the vehicle crossed the finish line this data was transmitted by a signal. Continuous transmission, however, was not possible due to skip zones. The number of sensors installed in the race cars in those days was still relatively small. In many cases, no more than ten parameters such as engine speed and various temperatures and pressures were measured. Since the early days, progress has clearly been achieved in terms of how the sensors operate: “Today, they’re a lot more accurate than 30 years ago,” says Modlinger.

Requirements vary according to the racing series

Today, the racing series grant the teams varying degrees of freedom with respect to data analysis. In Formula One and the FIA World Endurance Championship (WEC), for instance, real-time data transmission by telemetry is still permitted. The high-tech hybrid race cars in both series are each equipped with more than 100 sensors capturing thousands of parameters. This generates huge data volumes (“Big Data”). At Schaeffler’s partner Porsche, hundreds of gigabytes accumulate in the WEC sessions with the Le Mans winning vehicle, the 919 Hybrid. This data is analyzed by dozens of trackside technicians – in a room that due to its many computer screens is reminiscent of NASA’s Mission Control Center. In Formula One, the data is additionally transmitted around the globe to the teams’ factories by high-speed internet. Computers at the factories are fed with the data and then issue the best race strategy by means of simulation. In spite of the huge data volume, transmission takes less than a second.

By contrast, telemetry is prohibited in the DTM and Formula E for cost reasons. The number of sensors is limited by the regulations as well. The ABT Schaeffler FEO2, for instance, is equipped with 40 sensors and the Audi RS 5 DTM with about 50. “Data is logged while the vehicle is on track and downloaded in the pits and imported into a server following each run of the car. That way every team has immediate access to the data,” explains Formula E data engineer Markus Gröniger. “This is particularly important because, due to the compact schedule, we have only a maximum of 1.5 hours between the sessions for data analysis,” Gröniger adds, “plus, in Formula E, we very often race on new tracks without the benefit of data from the year before.” In the DTM, where qualifying and the race take place on a single day, it’s crucial to find the perfect setup quickly. By contrast, in the WEC, there are three free practice sessions before qualifying with a total duration of four hours – clearly more time to prepare the cars for the races.

For the drivers, data analysis has become indispensable today. “It allows you to see where you lose

VIVA LAS VEGAS



Data analysis plays a major role in racing simulators. The vehicle dynamics data required for programming is largely logged by data analysis. This guarantees a

high level of realism. Today, it’s standard practice for drivers and teams to prepare for upcoming races in the simulator. In January 2017, the Formula E campaigners can look forward to a very special event. At the Las Vegas eRace to be held during the Consumer Electronics Show, the professional racers will be pitted against ten fans on the digital race track in the simulator, competing for a handsome amount of prize money, one million dollars. The “rFactor2” software used is based on a program that is also utilized by Formula One teams.

time compared with the other drivers and what improvements you can make in terms of driving,” says Audi DTM campaigner and Schaeffler brand ambassador, Mike Rockenfeller. “However, the level at which you have to delve into the matter varies. Sometimes you can immediately see in which sector you lose time, for instance by braking too early. At others, you may be spending hours pondering the data together with the data engineer.” So, the days of just getting into the car and driving off are long gone. The more complex race cars have become the more the art of setting them up has evolved into a science.



THE AUTHOR

Lars Krone is at home on race tracks around the globe. In his private archive, which is “too large” (according to his girlfriend), he collects facts and figures from motorsport – either on paper or, in modern style, digitized. Whenever the fan of Japan is tired of watching car races, he seeks diversion by going to the movies or the seaside.

»» *The pleasant part about traveling is that even that which is ordinary appears like an adventure due to novelty and surprise*

Johann Wolfgang von Goethe

JOURNEYING INTO CARS

— A pinch of innovation, a touch of Hollywood, and here's looking at you: the most spectacular stand at one of the world's largest trade shows. Similar to the Hollywood movie "Innerspace," in which a miniaturized human travels through another human's body, a virtual adventure trip into the interior of an IC engine attracts trade show visitors to this stand at Automechanika 2016. With the new LuK RepSet 2 CT and a matching specialty tool, Schaeffler is launching this repair solution for dry double clutch systems. At the trade show, visitors had the opportunity to see for themselves how the tool works in the virtual world. That the virtual journey into the heart of an automobile will be possible as a "standard process" is just a question of time. "Vehicle applications and repair solutions are becoming increasingly complex. They generate a growing need for information and training, which will take place in virtual realities in the future," explains Dr. Robert Felger, Senior Vice President Product & Marketing at Schaeffler. 16 years ago, in 2001, Schaeffler embarked on the journey into the digital age, launching the www.repxpert.de/en online portal on which some 45,000 garage professionals are registered today.

outlook

Technology for tomorrow



DISTRIBUTION OF SALES BASED ON VIRTUAL REALITY TO VARIOUS SECTORS IN 2025 IN BILLION DOLLARS

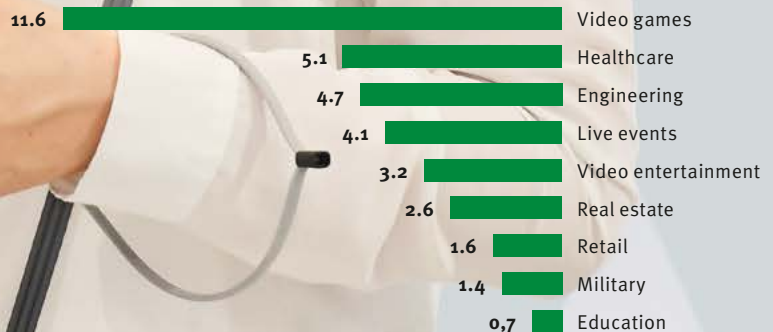

Source: Goldman Sachs Global Investment Research

VISIONARY DREAMERS

On land and sea, in the air, and through time: Mobility is a topic that also motivates the famous film studios in Hollywood. No matter how far out a vision from the Hollywood Dream Factory may be, years later, it seems to materialize in the real world.

— by Wiebke Brauer

LIGHT CYCLE TRON: LEGACY

Vehicle type Cyber motorcycle

Special features More than for its plot, the science fiction movie “Tron” from 1982 is remembered for the mopeds it featured, albeit the movie is regarded as a milestone in computer animation. The design of the motorcycles back then was created by Syd Mead (see also “Blade Runner”), that of the sequel by German automobile designer Daniel Simon.

Drive The cycles run on liquid energy and the rider accelerates by pulling the front and rear wheels apart which exposes the engine.

Curious detail For 55,000 dollars, street-legal replicas of the Light Cycle – albeit without the light-band function – went on sale when the movie was released in 2010. A 1,000 cc V2 Suzuki engine was installed to power the bike, and its steel frame was lined with fiber glass bodywork.





SPINNER BLADE RUNNER

Vehicle type Automobile

Special feature Vertical take-off capability

Drive IC engines, jet propulsion and a kind of anti-gravitation unit

Use Is mainly driven or flown by police for surveillance, and occasionally a rich citizen buys an illegal license.

Design Syd Mead worked as a design artist on movies like “Aliens” and “Star Trek.” He designed the light cycle from “Tron” and talked about “electronic herds” – something we call car-to-car communication today – as far back as 30 years ago. Asked about mobility of the future, Mead, who is now 83, once said that the question had not been answered so far, and that he didn’t know if the auto industry could find the right answer.



AUDI RSQ I, ROBOT

Vehicle type Automobile

Special features Fiberglass laminate body with “Lunarsilver” coating, gull-wing doors – plus spherical wheels allowing the car to maneuver in all directions. It’s a self-driving vehicle, an idea which, by the way, appears in Erich Kästner’s childrens’ novel “The 35th of May”. Kästner wrote it in 1931 and the fantasy also features moving sidewalks and cell phones.

Design The Audi RSQ specifically designed for the movie is based on a concept of the Audi Le Mans quattro, which subsequently was fed into the body design of the real Audi R8. “Integrating the spheres into the vehicle’s styling posed one of the greatest challenges to us,” recalls Julian Hönic, who was responsible for the exterior design of the Audi RSQ at the time.

DELOREAN BACK TO THE FUTURE

Vehicle type Automobile

Who invented it? Dr. Emmett L. Brown. He had the idea for it on November 5, 1955 when he slipped in the bathroom while trying to hang a clock on the wall and his head hit the sink.

Drive The DeLorean DMC-12 reaches the 140 km/h (88 mph) needed for the time leap by means of an IC engine that burns unleaded fuel. The additionally required 1.21 gigawatts are generated by a plutonium-fueled nuclear reactor at the rear. The rust-proof steel body of the DeLorean facilitates the "flux dispersal." Later, it is supplanted by a fusion generator from Fusion Industries that converts matter (household waste) into energy.

Good to know The flux capacitor is the device that makes time travel possible.

Design Giorgio Giugiaro



LEXUS 2054 MINORITY REPORT

Vehicle type Automobile

Special features A fuel cell powered mid-mounted electric motor with an output of 670 hp, a DNA recognition system, response to voice and gestures, autopilot, memory metals resistant to deformation, an infrared accident avoidance system.

Curious detail Director Steven Spielberg wanted a Lexus for his film – he drives one himself.

Good to know For the movie, a fully automated factory was designed in which vehicles, among other things, are produced using a predecessor of the 3D printer. A complete action sequence takes place during the production chain and ends in Anderton (Tom Cruise) fleeing in the finished car.



TRANSPORTER STAR TREK

Type of travel

Teleportation/beaming

Who invented it? Neither beaming nor the warp drive was originated by “Star Trek” creator Gene Roddenberry. In March 1877 the New York newspaper “The Sun” published a short story by Edward P. Mitchell titled “The Man Without a Body,” in which teleportation, as the title suggests, worked less than perfectly.

How does it work? A standard Starfleet transporter decomposes the object to be beamed into its atoms, sends these through a stream of matter and then rematerializes them at the destination.

Good to know In the Star Trek series, beaming was introduced for cost reasons in order to circumvent complex landing sequences on alien planets. By the way, the world famous phrase “Beam me up, Scotty” was never actually spoken in any episode.



K.I.T.T. KNIGHT RIDER

Vehicle type
Automobile

Drive Knight Industries turbojet with modified re-heat



Special features Pontiac Firebird Trans Am from 1982 with auto cruise and auto collision avoidance, homing device, turbo boost, super pursuit mode and an anharmonic synthesizer which makes it possible to imitate sounds and people, silent mode, microjam used to tamper with other electronic devices, CO₂, oxygen and oil nozzles, emergency braking system, built-in automatic teller machine, grapples, molecular sealing, communication via voice recognition in the car and via com-link/wrist watch – plus countless other gadgets.

Good to know The series' intro blurb "Knight Rider. A shadowy flight into the dangerous world of a man who does not exist ... a young loner on a crusade to champion the cause of the innocent, the powerless, the helpless ..."

EXOSKELETON ELYSEUM, IRON MAN AND ALIENS

Function They support the protagonists in tackling tasks such as lifting heavy loads in "Aliens" and in gunfights like those in "Elyseum," "Iron Man" (Powered Exoskeleton) or "Matrix Reloaded" (Armored Personnel Unit – APU).

Very real Exoskeletons are used by the military. The system by U.S. defense contractor Lockheed Martin is called "HULC Load Carrier" and enables soldiers to carry/wear gear weighing up to 90 kilos. Exoskeletons are used for industrial purposes as well and in medicine where the technology has been successfully supporting therapies or is used as a walking aid. The next step: bionics that fuse humans and technology in the form of smart prostheses networked with the brain.



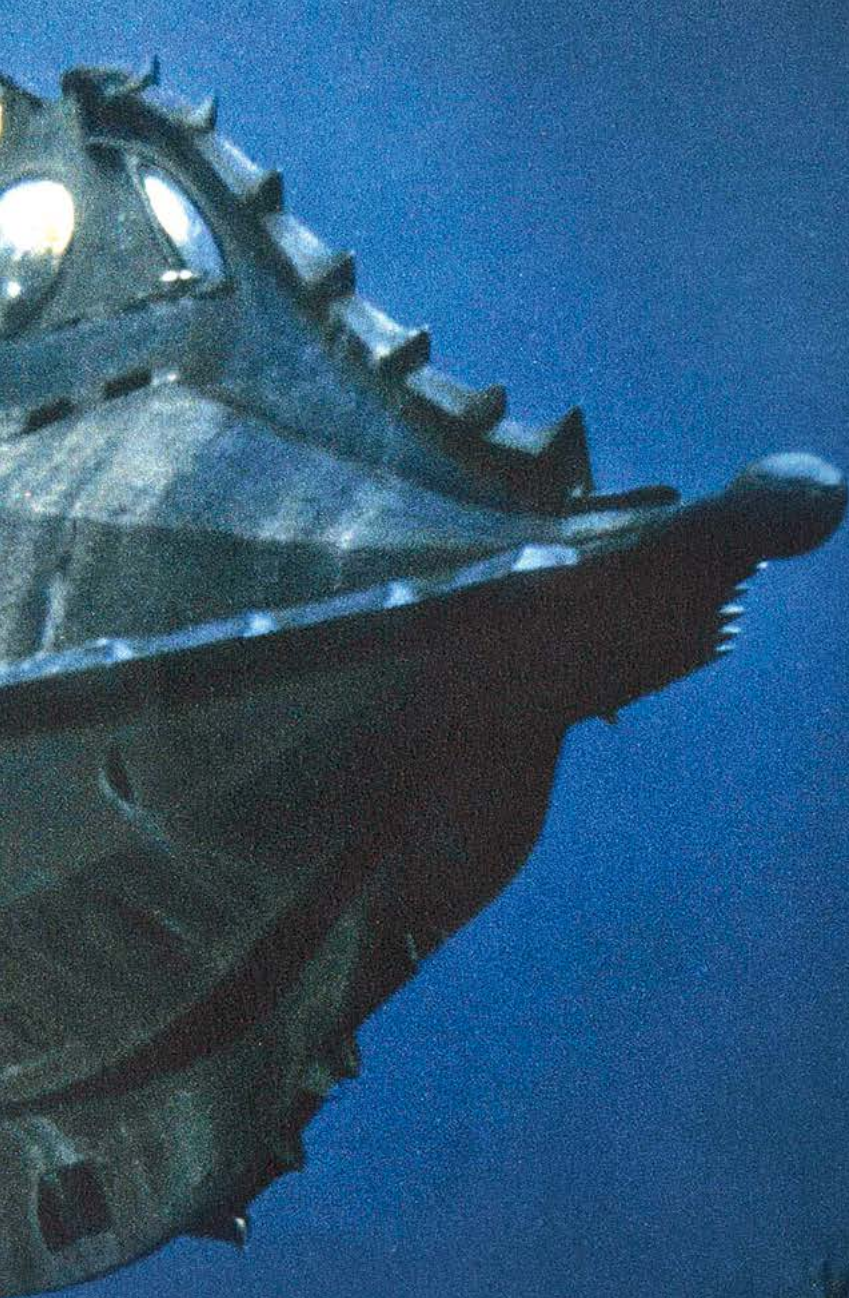

NAUTILUS TWENTY THOUSAND LEAGUES UNDER THE SEA

Vehicle type *Submarine*

Drive While in the movie from 1954 *Nautilus* uses nuclear power for propulsion, the original ship in Jules Verne's novel from 1870 is powered by electricity. More than likely, it is generated according to the fuel cell principle using sodium amalgam. The sodium is extracted from distilled saltwater. The required energy stems from coal being mined on the seabed. The *Nautilus* achieves a top speed of 54 knots, approx. 100 km/h (62 mph).

Design Jules Verne describes the cigar-shaped ship as being approx. 70 meters long, 8 meters wide and weighing 1,506 metric tons. Harper Goff, who designed it for the Walt Disney movie was inspired by sea monsters.

TUBE TRANSPORTATION SYSTEM *FUTURAMA*

Type of system *High-speed transportation*

How does it work? There's no explanation provided, but the TTS can be used for free, all it takes is to tell it where you want to go and the system will catapult you to your destination through transparent tubes.

Who invented it? The British engineer George Medhurst came up with the idea of using tubes for transportation. As far back as in 1799, he registered a patent for an "Aeolian engine."

Good to know In 2013, Elon Musk proposed a system that would propel people in pod-like vehicles through a tube on air bearings at a speed of up to 1,225 km/h (761 mph). The Hyperloop was originally planned to run from San Francisco to Los Angeles, now it's more likely that it will be built between Dubai and Abu Dhabi.



THE AUTHOR

Although Hamburg journalist **Wiebke Brauer** always found the "Knight Rider" series horrible, she wouldn't mind owning a Pontiac Firebird Trans Am – as long as it doesn't talk ...



Will machines be pushing a button someday to turn on humankind? Even experts like Elon Musk and Ray Kurzweil warn of the risks posed by forms of “superintelligence”



THE POWER OF THE MACHINE

Winning games, reading files, diagnosing diseases: will robots soon be smarter than people? And, if so, what will become of us?

— by *Wiebke Brauer*

— The human looks at the robot and says: “Human beings have dreams. Even dogs have dreams, but not you, you are just a machine. An imitation of life. Can a robot write a symphony? Can a robot turn a canvas into a beautiful masterpiece?” The robot looks at the human and asks: “Can you?”

Of course he can’t. The human’s name is Del Spooner – played by Will Smith – the movie is “I, Robot.” It’s not a very recent release, but its theme is all the more appropriate for our times – the fear that machines intend to surpass us with their artificial intelligence and extinguish us because we’re nothing but pests that destroy the planet. Interestingly enough, the three robot laws that prohibit machines in the film to harm humans were written by science fiction author Isaac Asimov in 1942, so the fear of computers is old as computers themselves.

Facts catch up with forecasts

The prediction that computers will be smarter than we has been made by Ray Kurzweil. The American is an

author, futurist and Director of Engineering at Google – and his priority at the moment is looking at “singularity,” which he defines as a fusion of humans and machines that will allow us to live forever. Now this could be dismissed as a ridiculous idea if the man hadn’t previously predicted the existence of cell phones, self-driving cars and intelligent weapons systems. Kurzweil himself no longer considers his prophecies to be as radical as in the past. This may be due to the fact that the development of artificial intelligence is taking place at such a rapid pace that it’s impossible to keep track of his predictions.

Artificial intelligence is encroaching on the domains of human smartness

Machines by now are not only better at playing chess but also at Go, which is an even far more complex game. In March, Google’s computer program AlphaGo beat Lee Sedol, the board game’s champion. “We’re in a complete state of shock,” the South Korean commented following his defeat. The machine’s victory was enabled by Deep Learning, artificial neuronal networks. Thanks

to Deep Learning, artificial intelligence is increasingly surpassing us in domains that, up to now, have been deemed to be realms of human smartness.

Algorithms recognize traffic signs and disease patterns, and distinguish cancerous from healthy cells, which means that not only taxi drivers or excavator operators will be replaced by self-driving vehicles – at some point in time, we’re no longer going to need doctors or journalists either. Even today, financial news are written by programs and some U.S. law firms use AI systems that plow through files with greater accuracy than any legal assistant. At the same time, it’s appropriate to say that industrialization and mechanization have always devoured jobs – and produced new ones.

Robotic referees heading for the Olympics

Even the job of the referee is threatened with extinction. The Fujitsu Corporation has jointly developed an automated referee with Japan’s Gymnastics Association that judges rhythmic sports gymnasts. The system is expected to be used in the 2020 Olympics in Tokyo. Why not? An electronic brain can’t be bribed and doesn’t tire.

It’s just that we have reservations about machines because they pass inhuman judgments and have no concept of values. In addition, we fear a loss of power – the discussions about automated driving being a case in point. Plus, we consider ourselves to be morally superior, albeit, of all reasons, because we feel that our personal judgments are the results of a cognitive process, except that artificial intelligence fares better exactly in this discipline.

Humanized machines

But at least we have feelings, feel love and cultivate relationships! The only question is what we mean by that. Even years ago, the U.S. company True Companion presented a sex robot called Roxxy that listens, talks, senses touch and whose personalities can be selected according to the owner’s whims – Roxxy may be shy on some occasions and bold on others. Roxxy was never particularly eloquent, but she arguably didn’t have to be. For Ray Kurzweil, there’s no question that we will be mating with machines someday, albeit primarily in virtual forms and with nanobots in our bodies sending sensory signals. “Sexual pleasure,” Kurzweil once wrote “is an invention produced by the brain itself – just like humor or rage.”

Those familiar with the HBO series “Westworld” have to rethink the meaning of the term empathy with respect to an individual and a machine anyhow. Based

on the novel by Michael Crichton and the same-named movie, “Westworld” tells the story of a western pleasure park populated by avatars in which humans treat machines like animals. As a viewer you feel bad – and empathize with the machines.

Who decides that robots have no dignity? In the debate about the distinction between humanoids and androids, the argument is essentially put forth that a computer has no body and hence feels no fear, no disgust and no happiness. Furthermore, machines, unlike humans, could not create but only replicate. No matter which way you look at it, the five-minute science fiction film “Sunspring” is the first work to feature a screenplay that has been entirely written by an algorithm.

Admittedly, the film primarily stands out due to its bizarre dialogs – but viewers of man-made television are certainly prone to suffer feelings of confusion as well. Plus, the number of original motion pictures isn’t very long either. Instead, we watch prequels, sequels, spin-offs or remakes. So much for human ingenuity.

Prominent warners

Yes, perhaps we have reason to be afraid. Astute people like the Swedish philosopher Nick Bostrom, Stephen Hawking, Bill Gates or Elon Musk indeed are and issue public warnings of an intelligence that is uncontrollably taking on a life of its own. However, the question is whether it will even be interested in us, which is hard to imagine. And what will it find? Humans staring at smartphones. In this light, we’ve already succumbed to the digital.



THE AUTHOR

*Although Hamburg journalist **Wiebke Brauer** is afraid of artificial intelligence and its consequences, she has no problem shifting parts of her brain to her iPhone. As a result, she remembers only two phone numbers – as opposed to countless ones remembered by the device.*

100 B

nerve cells are contained in the human brain. It weighs about 1,400 grams – and incurs pretty low maintenance costs. About 3,000 euros have to be spent on food while “air and love” are free. By contrast, **Sunway TaihuLight, the world’s fastest computer**, incurs annual electricity costs of eleven million euros. In return, it performs trillions of mathematical operations per second, compared with the “mere” ten billion by our brain. Another difference: we crash clearly less frequently – and when we do it’s typically by intent.

\$100.000

is the prize money awarded for passing the Turing Test invented by U.S. sociologist Hugh G. Loebner in 1991. The challenge is to create **a machine that convinces a tester that it’s a thinking human being**. Whether the chatbot “Eugene Goostman” in 2014 was the first subject to pass the test continues to be controversial. The chatbot passes itself off as a 13-year-old Ukrainian who, among other things, owns a guinea pig and likes Eminem.

85 %

is the **probability of a computer recognizing that a human being truly feels pain**. In a study conducted by the magazine “Current Biology,” a computer program checked videos of faces distorted by pain. Amazingly, only 50 % of the judgments made by humans were correct. By the way, Marian Barlett, who was in charge of the study, sells an app that by means of a smartphone camera decodes facial expressions to enable companies to better understand customer responses.

24

hours were spent on the internet by the self-learning chat program Tay before Microsoft had to remove it. **Tay was supposed to learn how 18- to 24-year-olds communicate and join the conversation**. However, within a short period of time, Tay drew Hitler comparisons, saw Donald Trump as the last resort and denied the Holocaust even before Microsoft was able to pull the plug. The problem was that, without major reflection, Tay inferred its responses from what other Twitter users had written.





IN SEARCH OF THE PERFECT ALGORITHM

Practically all automakers operate research facilities in Silicon Valley. New infotainment systems and automated driving are their main development goals.

— by Michael Kirchberger

— The list reads like the catalog of a major motor show. BMW and Daimler here, GM and VW there, Toyota and Tesla right around the corner. Silicon Valley in the south of the San Francisco Bay Area, not far from the Pacific coast, has arguably evolved into the most important location for the development departments of the automakers. The reason is that in the age of increasing electrification and digitization of mobility, the hardware of a vehicle no longer plays the key role. The supreme discipline, engine design and manufacturing – particularly of the German OEMs – is in a state of transformation. IC engines are increasingly exposed to criticism, and global warming, fine-dust pollution and stricter environmental regulations are paving the way for the electric motor. While electric propulsion is emission-free, it's also largely devoid of emotions. It doesn't give the automobile a special character, can offer neither exhaust

sound nor gasoline odor to horsepower freaks but, instead, provides vehicles of any kind with quiet and clean propulsion, even across longer distances, depending on the amount of energy stored.

The vision of automated driving

Apps – a term from the smartphone world – are now also found in cars. They help economically manage on-board energy – including developments from Silicon Valley. BMW, for instance, has perfected the control units of its electrically powered i-models in the valley of the programmers and visionaries. And to keep occupants from suffering boredom on the road, countless services have emerged that can be used for communication and telematics. GM has put its “OnStar” service



on track here, which provides a wide range of information and help via assistants. The third discipline that's going to change mobility more than anything else ever since the invention of the automobile is automated driving. This requires complex programs controlling the actions of the vehicle. The computer delivers algorithms for this purpose, clear instructions to handle a wide range of tasks. The term algorithm harks back to the Persian scholar Ibn Musa al Khwarizmi, who in Baghdad, around 825, wrote his compendious book "About Indian Numerals" that would subsequently conquer the mathematical world of the west as "Arabic numerals." The more precise and unmistakable these algorithms are written the better and more accurate can computers perform their operations. Therefore, the experimenters and thinkers in Silicon Valley are primarily focused on one particular task: the search for the perfect algorithm.

As early as toward the end of the past century, the automakers moved to the valley of promise, Daimler having been one of the first to do so, at a time when even the company preceding Google had not yet been founded. The technological solutions of the corporation's research vehicles were mainly created here. 240

employees are working at the Sunnyvale site and none of them goes to work wearing a suit. Instead of going to the cafeteria for lunch, they visit the food truck which, in addition to the typical fast food fare, offers healthy choices such as fruit salads and fruit smoothies, nourishment for good nerves being the way to go. And thinking out of the box is the way to go, too. Thoughts and notes are written on erasable walls, the grey cells stimulated in think tanks, and solutions worked out in teams. Current and visible results most recently were produced for the "Vision Van" Daimler project, a transporter for the future that will, obviously, be powered by electricity and realizes a wealth of approaches to moving goods in the coming decades.

The reason is that, according to a study, at least by 2020, about 80 percent of all consumers will no longer

Go west: BMW has had an office in Mountain View in the middle of Silicon Valley since 1988



From Silicon Valley to Las Vegas: Audi sent a self-driving A7 concept vehicle on a 900-kilometer route in early 2015



HANDS OFF

Can an internet giant build cars? Google has been testing automated driving on public roads since 2012, having covered several millions of test kilometers to date.



be shopping at supermarkets, but on the internet and using delivery services. Consequently, the delivery market will be growing. Even small ordering quantities are going to be in demand, for which developers have come up with a shelf system for vans that remembers what goods have been deposited where. A colored light system indicates to the driver where to find the merchandise again after having reached the delivery destination. This facility is owed to the fact that personnel turnover rates are typically high and time to break in new personnel scarce. The computer at the company's headquarters, connected to the drivers via smartphones and apps, not only handles route guidance to the customer's location,

but also forwards information like, "don't ring the bell, just knock because the baby's asleep."

Drone delivery, just-in-time

The combined use of vans and drones which the Daimler thinkers are developing in the Valley for express deliveries seems very futuristic as well. A tradesman, for instance, who breaks a grind disk on a tool, could quickly receive a spare this way. The roof of the van serves as a pad, where it would automatically land. Before it does, the recipient and the van driver would only have to confirm safe landing by sending an app message.

Other brands are looking for partners to implement their plans for the future. The spectacular partnership between Fiat Chrysler (FCA) and Google for the development of autonomous cars has caused a stir. It's a win-win situation for both: Google now has access to roadable vehicles for testing the self-driving technology after the proprietary vehicle of the internet giant used to be more reminiscent of a carousel vehicle than an automobile. And Fiat Chrysler, with a mere signature, recovers the obvious deficit that existed with respect to these forward-thinking technologies. Google is now running additional tests with 100 Pacifica minivans, thus doubling the fleet of trial vehicles. In Europe, it is assumed that the recently presented Stelvio SUV from Alfa Romeo will be prepared as a test vehicle.

Meanwhile, GM is not about to step back, having bought the startup Cruise Automation founded three years ago for about a billion dollars. As a result, the company has acquired a technology in which drivers can switch on the self-driving function, which is also



suitable for retrofitting, by pushing a button. The system had originally been planned for tractors and dump trucks. Now the plan is to retrofit self-driving taxis from Lyft. GM, however, was driving developments for autonomous cars forward even prior to the acquisition. As early as next year, the Cadillac-CT6 is said to be offered with the option of being equipped with this technology.

So, the future has long begun, and whether or not it will continue to include Driving Pleasure due to

“Vorsprung durch Technik” remains to be seen. A positive, no doubt, is the fact that the number of accidents can be expected to significantly decrease, considering that currently 92 percent of them are attributable to human error. Provided that the algorithms are truly perfect. After all, they will have been programmed by – humans.



THE AUTHOR

Michael Kirchberger, born in 1957, is editor-in-chief at Global-Press (Motor Information Service). He writes for F.A.Z. and other print media. His means of transportation include cars, motorcycles and campers, and he also likes to occasionally put his hands on a helm instead of a steering wheel.



Daimler employs 240 people in Sunnyvale. Their mission: thinking out of the box and inventing, for example “Vision Van” (above)



THE FUTURE IN A CAROUSEL

Something that's as comprehensive and defines society as much as mobility does, always involves the interaction of many planners and doers. An overview of the players and their motives and objectives – plus the resulting opportunities and challenges.

— by Christian Heinrich

THE INNOVATORS

*The future of mobility is not being shaped by traditional automotive brands such as BMW, Daimler and Volkswagen, but rather by companies like Alphabet (formerly Google), **Schaeffler** and numerous startups that determine the direction in which mobility is headed. At least, this*

is the impression that has recently emerged. In terms of innovations, it's suppliers, versatile internet companies and ingenious startups that are at the very front of the field. While some automakers haven't launched even a single electric vehicle yet, self-driving Google cars were already traveling the roads of the U.S. state of Nevada as early as in 2013 with a human in the driver's seat only to intervene in case of an emergency. And with a bio-hybrid pedelec – a mix of a car and an electric bicycle combining the benefits of both – Schaeffler defines alternative options for people to move from A to B in the future. The innovators, as we refer to this group of companies, are the ones driving the technological development of mobility most intensively of all. (By contrast, many of them usually leave it up to others to recognize risks and emerging safety issues.)



OF MOBILITY OF INTERESTS

CITIES AND **LOCAL GOVERNMENT**

*Mobility is always only as good as the environment in which it's embedded. In a medieval-age Germany, the cards would have been stacked against motorists: practically nothing but dirt roads full of potholes, mud and no asphalt. Only the modern autobahn and road network, and car-friendly urban layouts facilitated the utilization of the automobile so that it soon evolved into a symbol of freedom. **Now the impending changes in mobility are making new demands on cities and communities, and their planners and architects** who are charged with embedding mobility in them. Smart Cities are a hot topic in this context. Cities that are networked from traffic lights to solar panels on high-rise buildings "know" to a certain degree what's happening and needed at a particular point of time, and can systematically guide information and even control mobility streams to some*

extent. This may even go as far as a fleet of autonomous cars waiting to pick up guests at the end of a birthday party. But architects also have to create space for the diversity of available transportation options. Thanks to e-bikes, bicycle paths will likely become even more important than they already are today. Plus, there's a need for charging stations for electric vehicles, no matter what they'll look like. In a modern city of the future, the charging station will be what the phone booth was at the end of the 20th century: omnipresent. But why should cities and local governments invest so intensively and why should urban planners and architects pay so much attention to mobility? The answer is because it serves their best interests. Cities paving the way for mobility of the future become more attractive – because their quality of life increases.





THE GOVERNMENT

Enormous responsibility: this is how the role of the government with respect to mobility of the future could be put in a nutshell. In the face of diverse resistance, the government has to guide the development of mobility in an environmentally compatible and sustainable direction, and to thus nudge Germany's automotive industry to embark on the journey to the future. The tools available to this guiding process are powerful ones: they're called laws. Laws make it possible to create environmental zones permitting only low-emission vehicles to enter and to levy special taxes on older cars that emit particularly large amounts of pollutants. The catalytic converter, for instance, can only be found in practically every car today because it has been mandatory in Germany since 1984. Now the government is trying to achieve the break-

*through for electric mobility. At the moment, electric vehicles are exempt from road tax for ten years and consumers buying a new electric car – thanks to the industry chipping in – receive 4,000 euros from the government. While, so far, the hoped-for run on battery-electric vehicles has not taken place, the way has at least been paved for it to some extent. Now the ball just needs to get rolling. When that happens, the government will be taxed to act in another respect. **By means of laws, it has to establish boundaries and a framework** where the technology of automated driving enters new dimensions. It can be expected that the legal situation regarding accidents and the rules to avoid them will soon be fueling an intensive debate – resulting in even more responsibility for the government.*



RESEARCH INSTITUTIONS

Why not use a completely different approach to all this? Couldn't flying single-occupancy objects be the solution to traffic jams? As part of the EU's "myCopter" project, the Max Planck Institute for Biological Cybernetics and the Karlsruhe Institute of Technology (KIT) are conducting exactly this kind of research. Aren't there alternatives to the lithium-ion battery after all? Material scientists from Gießen University are performing research on sodium-oxygen batteries. How can rechargeable batteries be re-used in meaningful ways when they become weaker after years of service? Researchers at TU are working on particularly sustainable methods to recycle lithium-ion batteries. **The role universities and research institutions play in the future of mobility corresponds to the one they've defined for themselves and their function in society.** They attempt to expand the boundaries of knowledge to some extent. Particularly in those sectors where field use is still in the distant future and which therefore tend to be neglected by companies that conduct research, universities and research institutions can provide decisive new impulses.

THE ENERGY SECTOR

From car sharing to flying single-occupancy drones there are many conceivable variants for mobility of the future. There's one thing that's common to all of them: **transportation requires energy.** Today, it's still primarily supplied by gasoline and diesel fuel, but there are many indications that electricity will someday be the dominant source of propulsion. If this should actually be the case in the future, then even today a crucial detail poses the question of "when" it will be. While gasoline and diesel are available practically anywhere via an extensive network of filling stations, electric mobility is struggling with the issue of its availability via a network of charging stations. Obviously, every normal household socket supplies electric current – it's just that an electric vehicle has to be plugged in overnight to fully charge

its battery. That's much too slow – and thus not practical. The solution is charging stations that reduce the charging process to 20 minutes. But in all of Germany, there aren't even 6,000 of them. By contrast, there are three times as many, 15,000, conventional filling stations – where refueling, by the way, takes only one to two minutes. But thousands of charging stations can't be built just like that. The capital expenditures required to catch up with the normal filling station network are enormous. So the great challenge posed to the energy sector and many of the other players mentioned here is this: the electricity is in the grid and now it has to be sent to where it's needed – to the electric vehicles. At the end of the day, availability will be the factor that determines how long it will take for electric mobility to achieve its breakthrough.



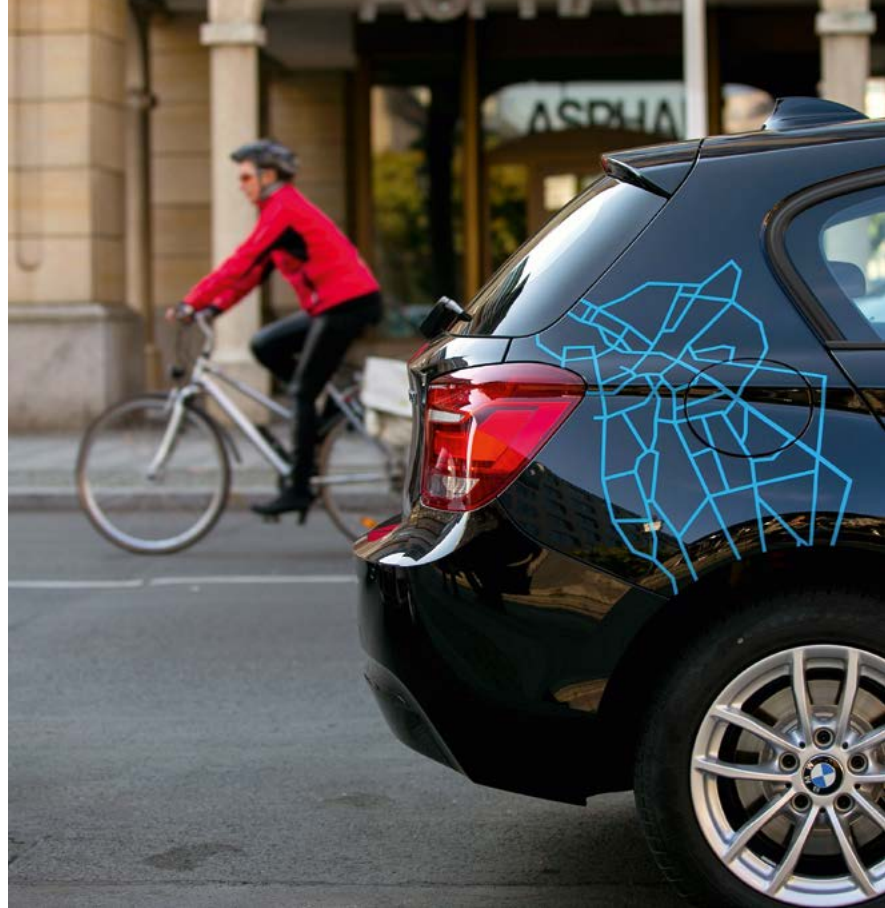

PRIVACY PROTECTORS

The following scenario has in part already become reality on several test routes in Germany: a traffic jam starts behind a corner and the cars braking and stopping transmit their information to oncoming vehicles which, in turn, after a few hundred meters, “warn” the cars that are just approaching the traffic jam. Because the cars know the driving styles of their operators, they issue particularly loud and intensive warnings to those that tend to drive aggressively. Meanwhile, a traffic light has been informed about the traffic jam and the control center is aware of the situation as well. Such car-to-car and car-to-x communication in a so-called Smart City **provides the vehicle and its driver with timely information and a feeling of maximum safety.** A brave new world of mobility – that also has its downsides

because those who communicate a lot reveal a lot about themselves as well. Driving styles could be of interest to insurance companies. And what about tampering attempts? Even today, there are cars on the market that to a limited extent can be controlled by smartphones. What if someone who’s not authorized to do so takes control? And how can self-driving cars actually be protected against hacking? Data protection and security experts are challenged to keep an eye on all the downsides that progress entails. In doing so, they always have to assume worst-case scenarios, which doesn’t necessarily make their role any easier in a world that increasingly embraces technology. Yet especially because of the wide-spread enthusiasm for the future, their objective assessments will be crucial.

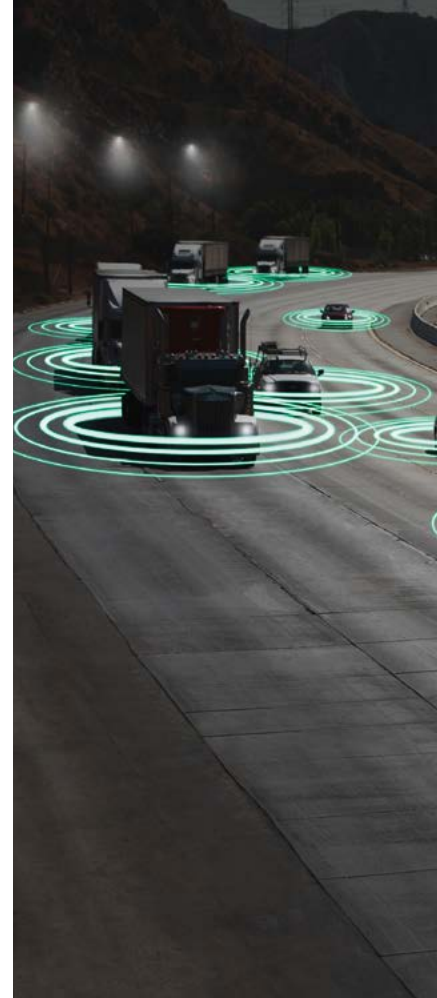



MOBILITY SERVICES PROVIDERS

The days are gone in which mobility still meant boarding a bus or getting into one's own car to move from A to B and back. Anyone who steps out of their house today or has flown to a new city has **various mobility options to choose from and will select the one best suiting them under the circumstances**. Particularly in big cities, besides public transportation for short- and long-distance travel such as buses and trains, car sharing options like car2go or DriveNow, city bike rentals, electric bikes or, abroad, the ride-sharing service Uber that hauls people from A to B in privately owned vehicles, are available. Or, quite in keeping with the current trend, a combination of several of these options is chosen. In a few years' time, there'll addition-

ally be the autonomous cars from Google and company as another important, if not the most important, player in this field. Most mobility services providers couldn't care less about what source of propulsion will be used, be it gasoline, electricity or hydrogen. The connecting lines of the mobility network are the crucial elements. Some of them are heavily frequented with many people being hauled at the same time, for instance on subway lines, but create only a coarse net. The very fine branches on the other hand are the result of the practically personal mobility of individuals, for instance those using car sharing services or rental bikes. Both, large nets and small branches are being shaped in large part by the mobility services providers.





CLUSTERS

At first glance, we're living in an age of ideas. **An individual with a brilliant idea can set a lot of things in motion in very short time.** Matternet, for instance, is a company that was "born" in a university course at Stanford. Today, it produces drones intended to deliver pharmaceuticals in Africa. But when it comes to transformation of mobility as a whole, for instance the switch from gasoline and diesel to electricity, in view of the large number of players involved, it takes more than just a single idea, but a good and, above all, common plan to smoothly bring fundamental change into society. For instance, regional standards for the design of plugs at charging stations are a prerequisite for the success of electric mobility. Other challenges, like increasing battery capacity that is still perceived as being too low and new approaches to lightweight design, are easier to master as collaborative efforts as well. In the German "cluster" billed as "National Platform for Electric Mobility," for instance representatives of automobile manufacturers, mobility services providers, research institutions, universities, the government and others have teamed up in six working groups. Such clusters can be expected to play a key role in the further development of mobility.

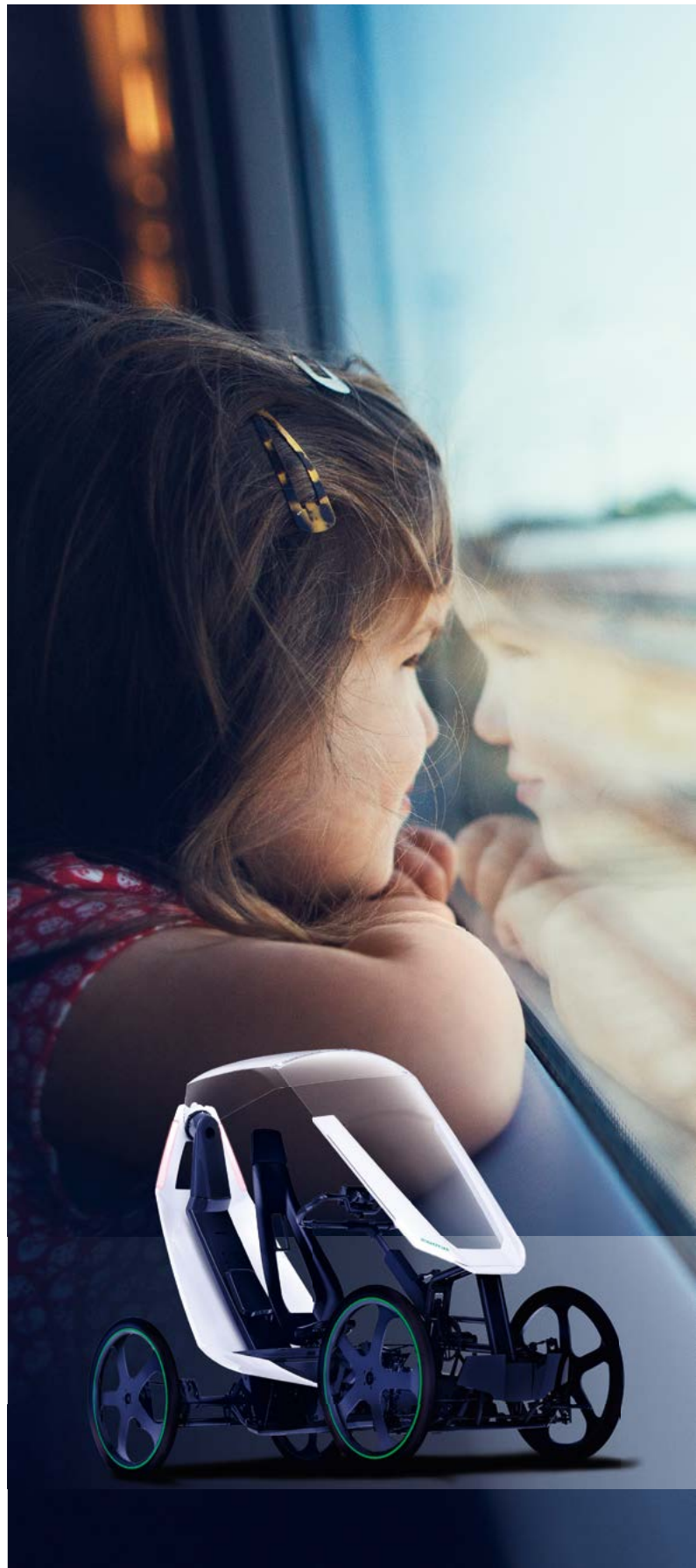

USERS

Assuming a train service between Berlin and Munich takes an hour longer than usual but, instead, is operated using one hundred percent electricity generated by a particularly sustainable solar park. The eco-conscious user will gladly accept this because the environmental footprint is okay in this case. For a business executive standing in line at the ticket counter, the longer transit is a waste of time as he or she is mainly interested in fast travel. A third passenger may primarily be interested in price. He or she will accept longer transit times if that

makes the tickets cheaper. All users have their own sets of values and priorities. But taken in isolation, they exert little influence. However, all users with similar interests as a group not only have power, but also make a crucial difference as, **to some extent, they will determine the future.** After all, it's the users who by utilizing or rejecting options decide if something is adopted or not. In addition, their purchasing decisions make a statement about the option – in terms of how practical, moral, praiseworthy and rewarding it is.



THE AUTHOR

Christian Heinrich works as a freelance science journalist in Hamburg. He has driven all-electric vehicles on several occasions from car sharing plans and is thrilled. Incidentally, there are two quick-charging stations in immediate proximity to his home. Now he's toying with the idea of buying an electric car – but not before prices have significantly dropped.

MEGATREND MOBILITY

In projects billed as **Mobility for tomorrow**, Schaeffler, today, is already researching and developing intelligent answers to the future challenges in the mobility sector (pictured: Schaeffler Bio-Hybrid), with a particular focus on electric mobility. But with IC engines, as well, Schaeffler still sees optimization potential of up to 30 percent and reg-

ularly presents innovative improvements. And, obviously, the combination of ICEs and e-motors – in other words hybrids – is a hot topic too. Here Schaeffler is working on diverse concepts – from micro hybrids to high-voltage solutions. The topic of mobility also plays a role for Schaeffler in the motorcycle, bicycle, rail vehicle and aerospace markets.



MODERN TIMES

Just as we've gotten used to assembly lines and robotics in factories, we're in the midst of the Industry 4.0 transformation.

— by Dr. Joachim Becker

— Progress is a long, steady flow – at least in retrospect, although the mechanical loom triggered a veritable revolution in the 19th century. During the transition from an agricultural to an industrial society the lives of many people fundamentally changed. Today, we’re on the threshold of a new technological age. Again, we’re in the same shoes as Charlie Chaplin was in his movie “Modern Times.” Again, the ways we produce, work and live are changing and again, the rapid pace of transformation entails insecurity.

The lines are blurred

The fourth industrial revolution has been building on the micro-electronic revolution ever since the mid-1970s. “It is characterized by the fusion of technologies, which means the lines between the physical,

Shoes, tools, model cars: 3-D printers are regarded as prime examples of smart production



Sensors capture information such as pulse rate or blood pressure and forward it to respective apps or emergency medical services. Some of the e-health wearables even work as tattoos



the digital and the biological spheres are blurred,” says Klaus Schwab. The executive chairman of the World Economic Forum in Davos is not alarmed by the increasing pace of transformation. Quite to the contrary, technological innovations, in his view, are going to raise efficiency and productivity. Klaus Schwab talks about a “miracle on the supply side” of the market. “The costs for transportation and communication will decrease, global logistics and supply chains will work more effectively and costs for trade will shrink – resulting in the emergence of new markets and accelerated growth.”

Acceleration and networking even added momentum to the first industrial revolution (back then due to rail transportation, road and canal construction). Today, even the smallest computers send their data on journeys

around the world. Over nine billion networked devices produce 2,500 petabytes of data per day. A comparison shows how large the data space is – this measuring unit from digital technology has no less than 15 zeros. The aggregate of all books that have ever been written is 50 petabytes. Google in the whole year of 2009 is said to have aggregated a data volume of 24 petabytes. Today, the Californians are processing nearly the same data volume – daily, with more than a hundred times as much data being produced around the world.

Experience remains an important helper

However, their sheer volume isn't what makes data valuable yet, as Industry 4.0 shows. To network products with machines and machines with each other, two disciplines have to come together which previously didn't have a lot to do with each other: mechanical engineering and IT. The objective is clear. Smart factories are to accelerate manufacturing, detect production errors early and help develop future products more efficiently. However, such factories only become truly smart based on a wealth of historic experience. It takes a great deal of knowledge about the correlation of effects in manufacturing to derive reliable information and concrete measures from the data gained.

When discussing Industry 4.0 it's frequently said that the machines diagnose "themselves." But initially it's the specific technical know-how of people that brings to light useful information from the deep data lakes. The art lies in not only descriptively analyzing data and eliminating errors, but in predicting future events before they occur. Accordingly, the machine is serviced with pinpoint precision before it fails or starts producing scrap. This predictive approach becomes even more important as an increasing number of sources (including unstructured data from the internet) converge. This is when experts talk about Big Data and typically think of the big internet platform providers in the United States and China. Clearly, a customer-centric approach with shorter and shorter innovation cycles requires putting an end to the separation of previously discrete data silos in manufacturing, development and sales functions.

Seamless communication

Industry 4.0 aims for the seemingly impossible: combining the efficiency of mass production with the flexibility of a small factory. In the future, the tailored, customized product is supposed to be made at lower production costs than the previous large-volume articles. To achieve this ambitious aim, the factory floor has to "organize itself." The products have to know at all times where in the production run they're located and be

able to independently head for the machines. The prerequisite for this is seamless communication of all the systems involved in the Internet of Things. Consequently, the machines no longer necessarily need computing power, but the connection to a cloud that can analyze countless data in real time.

Intelligent rolling bearings from Schaeffler show how machines can capture both their maintenance needs

INNOVATION PROJECT "MACHINE TOOL 4.0"

Building on a concrete investment project, experts from Schaeffler, in a partnership with DMG MORI, are developing a machine concept billed as "Machine Tool 4.0." From sensors to the cloud, it integrates existing technology in a network with digitized components and marks a tangible step in the direction of digitized production. The possibilities for digitization aren't limited to the production machine, as the production environment benefits from end-to-end data flow in the value stream as well. With Machine 4.0 manufacturers are embarking on a deliberate journey toward digitized production. The data collected is analyzed both locally and in a Schaeffler cloud in order to feed the results back to various local functions. At the JIMTOF trade show in Japan in November 2016, Schaeffler and DMG MORI sealed the continuation of their collaboration in this and other innovative projects such as the development of additive manufacturing technologies for rolling bearing components.





From the transshipment port to the delivery van of your parcel service: by means of RFID (identification using electromagnetic waves) parcels can be located – another segment in the Internet of Things



and the state of the product. Forces, torques and rotational speeds can be precisely measured on the moving parts. In addition, there are measurements of changes in the bearings due to wear, in other words lubrication conditions, temperature, vibrations and frequencies. Consequently, the bearings not only transmit forces and motion, but become sensors that are distributed everywhere. The aggregate of the data they collect produces a precise, virtual picture of the machine's condition. This provides tangible benefits, for instance in rail technology (see pp. 82–85).

Faster, better, more efficient

When the wheel bearings in trains measure solid-borne noise, temperature and rotational speeds this not only allows operating costs to be reduced but reliability and safety to be increased as well. If a defect is detected the networked rolling bearing can send an early safety warning to the operator via the cloud. "Thanks to analytics, valuable primary data turns into profitable information from which we develop innovative, data-based services for our customers," says Prof. Peter

Gutzmer, Chief Technology Officer of Schaeffler AG. The foundation is a secure software platform which protects the wealth of data against undesirable viewing or even tampering. Schaeffler recently announced a strategic partnership with IBM (see pp. 62–71). Since October 2016, the first Schaeffler cloud has been ready for initial applications.

All industrial revolutions have been driven by the desire to bring products to market faster, better and more efficiently. However, due to Big Data, the products themselves change and in part are replaced by services. "Mobility on demand" is just one example from the automotive industry. It requires cross-company standards that make data from the silos of the respective manufacturers compatible. U.S. IT corporations have already created de facto standards for many digital components, networking technologies and Big Data business models. One of the most exciting questions relating to Industry 4.0 at the moment is who will be shaping the standards here. A platform that pools the special know-how of German machine manufacturers doesn't exist yet. Such a data marketplace will change the rules of engagement in the industry – similar to the way the first mechanical loop did more than 200 years ago.



Today, smart cars can already be opened by apps and assistance systems take control in difficult situations (top). In smart homes, heating and lighting systems can be operated by means of apps. This optimizes energy management

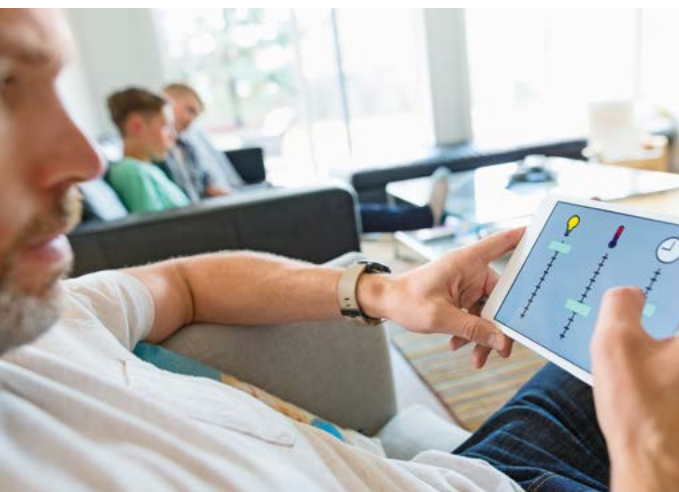

THE AUTHOR

4.0 is not a soccer result. Dr. Joachim Becker (born in 1963) knew this much before recently moderating his first conference on "Big Data and Industrial Analytics." As technology editor of "Süddeutsche Zeitung" he's been accompanying the factory on its way to the cloud for quite some time.

MASTHEAD

Published by

Schaeffler AG
Industriestraße 1–3
D-91074 Herzogenaurach
www.schaeffler.com

Communications, Marketing and Investor Relations

Christoph Beumelburg
(Senior Vice President)
Jörg Walz (Automotive)
Martin Adelhardt (Industry)

Concept

Jörg Walz (Schaeffler)
Thomas Voigt (Speedpool)

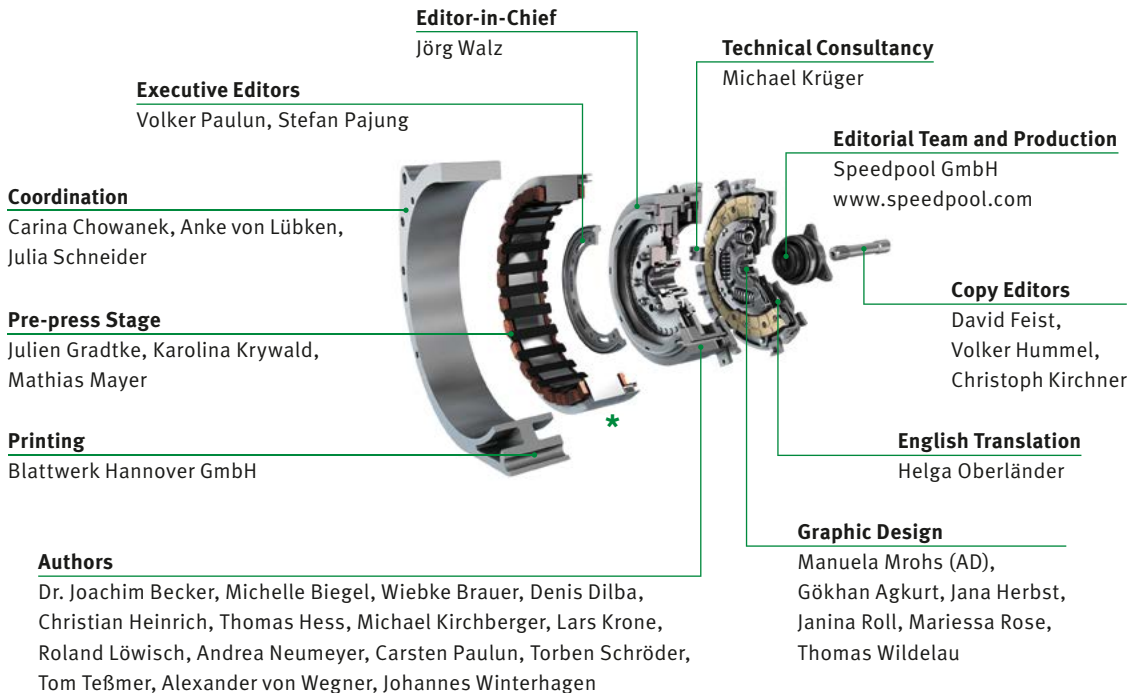

Photo Credits

Front page: abb/Fotolia; p. 3: Schaeffler; pp. 4/5: Angelus Liam/Fotolia, ihoe/Getty, Getty, Schaeffler; pp. 6/7: Angelus Liam/Fotolia; pp. 8/9: Fotolia, Getty; pp. 10/11: Nokia; p. 12: Brorsson/Wikipedia; p. 13: Danske Bank; pp. 14/15: Jasper James/Getty; p. 16: Schaeffler (2), Dong Wenjie/Getty; pp. 18/19: Zora Zhuang/Getty; pp. 20/21: Future Publishing/Getty; p. 23: Ariane Soldevilla/Getty; p. 24: Joey Luna/Getty; p. 26: Thomas Ledl/Wikipedia; p. 27: Yann Arthus-Bertrand/Getty; pp. 29–33: Illustrationen Thomas Wildelau; pp. 34/35: ihoe/Getty; pp. 36–41: Schaeffler, Audi, Porsche, ABT; pp. 42/43: studiotoks/Fotolia; pp. 44–47: Shutterstock; pp. 48/49: Shutterstock, Ryan Etter/Getty; p. 51: Mark Garlick/Getty; p. 52: Ivan Smuk/Colourbox; p. 53: Shift School; p. 54: Fred Froese/Getty; pp. 57–59: Werke; pp. 60/61: Getty; pp. 62–71: Schaeffler; pp. 72–75: Michael Kunkel; p. 76: Schaeffler; p. 77: Factories; pp. 78/79: Mina De La O/Getty; pp. 80/81: Schaeffler; p. 82: Nikada/Getty; pp. 83–85: Schaeffler; pp. 86/87: Michael Kunkel/Hoch Zwei; p. 88: Audi, Porsche; pp. 89–91: Michael Kunkel/Hoch Zwei; pp. 92/93: Schaeffler; p. 94: ZUMA Press/Imago; p. 95: Warner Bros/Getty, Imago; p. 96: Imago; p. 97: Lexus, Imago; p. 98: NBCUniversal, Inc./Getty, Marvel 2016; p. 99: Imago, Futurama Comics/Panini; pp. 100–103: Colin Anderson/Getty; p. 104: Andreas Koeberl/Getty; pp. 105–107: Factories; p. 108: Steve Proehl/Getty; p. 109: Schaeffler; p. 110: Monty Rakusen/Getty, mbbirdy/Getty; p. 111: Bloomberg/Getty; p. 112: Bloomberg/Getty; p. 113: Paul Taylor/Getty; p. 114: Thomas Trutschel/Getty; p. 115: Jekaterina Nikitina/Getty; pp. 116/117: da-kuk/Getty; p. 118: Guido Mieth/Getty, Maciej Frolow/Getty; p. 119: Schaeffler; pp. 120/121: nullplus, Christian Petersen-Clausen, Martin Dimitrov, Hero Images/all Getty

DON'T MISS THE NEXT ISSUE OF **tomorrow**

We'll be pleased to include you
on our mailing list
tomorrow@schaeffler.com



You'll also find all issues in
digital form in our media library
www.schaeffler.de/tomorrow

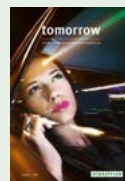

01/2015



02/2015



03/2015



01/2016



02/2016



03/2016

tomorrow has won recognition

Silver winner
'Custom Publications /
Corporations: Technology'



Shortlist
'B2B: Industry /
Technology /
Automobile'



Special Mention
Excellent
Communications Design
Editorial



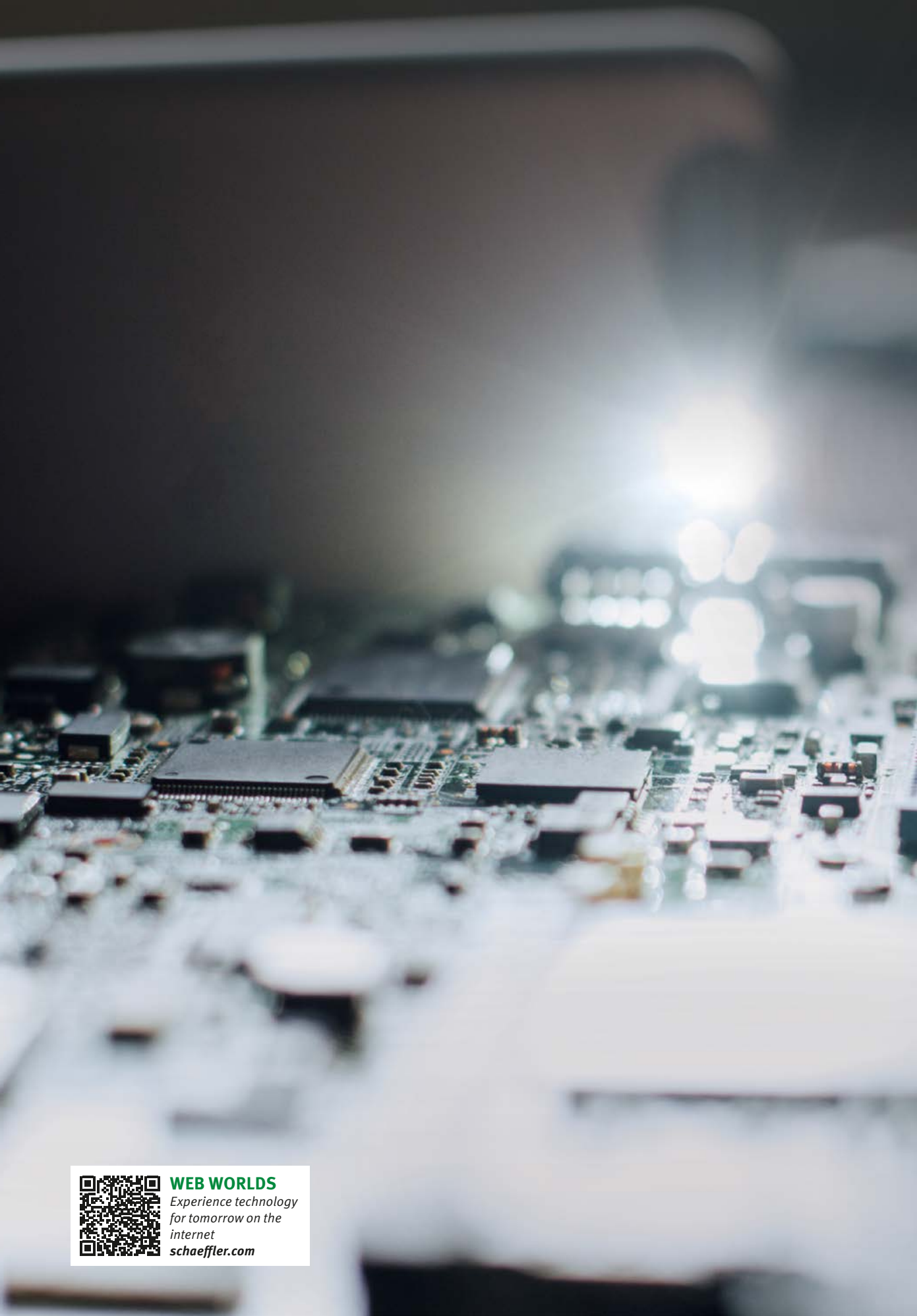

WEB WORLDS

*Experience technology
for tomorrow on the
internet*
schaeffler.com